

AgieCharmilles

CUT P

350 Pro/550 Pro/800 Pro



Becoming better every day – since 1802

GF Machining Solutions

When all you need is everything, it's good to know that there is one company that you can count on to deliver complete solutions and services. From unmatched Electrical Discharge Machining (EDM), Laser texturing, Laser micromachining, Additive Manufacturing and first-class Milling and Spindles to Tooling and Automation, all of our solutions are backed by unrivaled customer service and expert GF Machining Solutions training. Our AgieCharmilles, Microlution, Mikron Mill, Liechti, Step-Tec and System 3R technologies help you raise your game—and our digital business solutions for intelligent manufacturing, offering embedded expertise and optimized production processes across all industries, increase your competitive edge.



+ We are AgieCharmilles.
We are GF Machining Solutions.

Contents

6	New CUT P Pro series
8	Mechanics
10	UNIQUA
16	Electronic components
18	Automotive
20	Medical
22	Packaging
24	IPG: Intelligent power generator
26	Spark Track
27	ISPS: Intelligent Spark Protection System
27	iWire
28	Dedicated technologies
29	Turbo Tech
30	TAPER-EXPERT
31	AWT: Automatic Wire Threading
32	ASM: Automatic Slug Management
33	ASW: Automatic Slug Welding
34	System 3R Tooling Automation and software
36	Connecting you to the future
38	Sustainability
39	Energy Efficiency Certificate
40	Academy
42	Our Service + Success range
44	Available options
46	Technical specifications
50	About GF Machining Solutions

Precision, Reliability, Performance

With reliable mechanics, advanced technology features and a new HMI, the new CUT P Pro series delivers unmatched precision and performance for EDM applications.

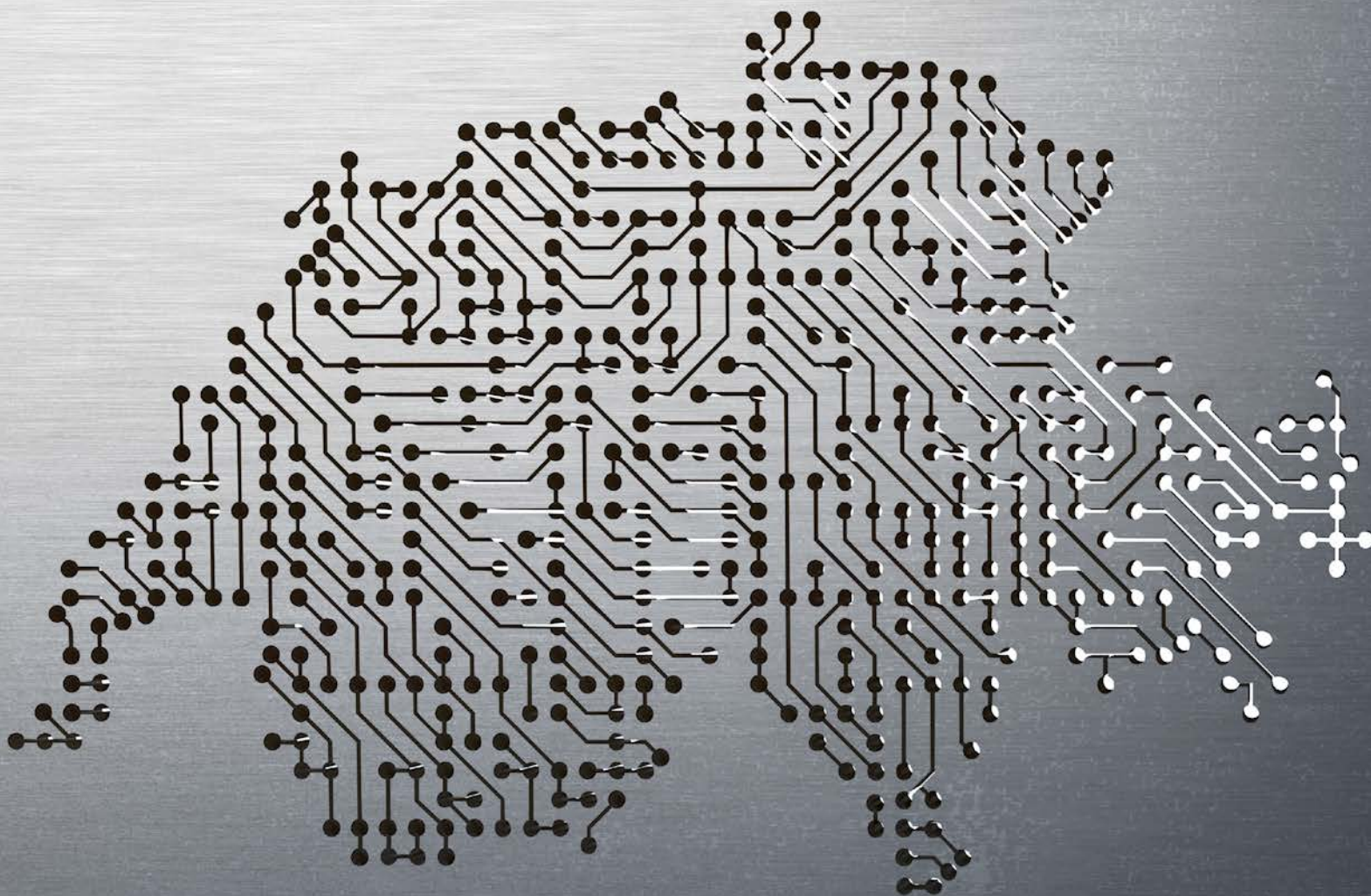

1943

Russian scientists Dr. Boris and Dr. Natalya Lazarenko discover the controlled erosion of tungsten electrodes submerged in dielectric fluid.

1952

Launch of the CHARMILLES EDM division at Ateliers des Charmilles in Geneva.

1954*

First industrial EDM machine tool, the CHARMILLES Eleroda D1; AGIE created in Basel.

1969*

First industrial numerical-controlled wire-cut EDM machine tool, the AGIECUT DEM-15.





+100 Years of EDM experience made in Switzerland

1973**

Creation of conical cut and coaxial flushing for wire EDM machines.

1978**

First patent for coated EDM wire.

1985**

Thermal cut and preparation of EDM wire (ThermoCut).

1996**

Creation of Surface Integrity (SI) generator.

1998**

Creation of automatic wire change (twin wires).

2003**

500 mm²/min cutting rate for wire-cut EDM machines.

2011**

Integrated vision unit (IVU) with in-process optical measurement for high-precision wire EDM.

2021

CUT P Pro series with Uniqua

* World premiere

** Global innovation



New CUT P Pro series

Reliable, Precise Cutting for Your Success

Quadrax +

IPG-DPS +

Spark Track +

Dedicated technologies +

AWT – Annealing +





- + **Thermostabilization**
- + **Anti-collision**
- + **Uniqua**
- + **Automation Ready**
- + **Connectivity**

* Some elements may be available as options or unavailable on some models

The framework

Mechanics

QUADRAX[®]

In the QUADRAX[®] system, the table, work tank and dielectric liquid remain stable, and the workpiece does not move. The axes are equal in length (X = U travel; Y = V travel), with constant, lower mass and completely independent movement, unlike other structural concepts. In addition, the base offers lower thermal conductivity and a vibration damping system.

up
to **3,000 kg**

up
to **510 mm**

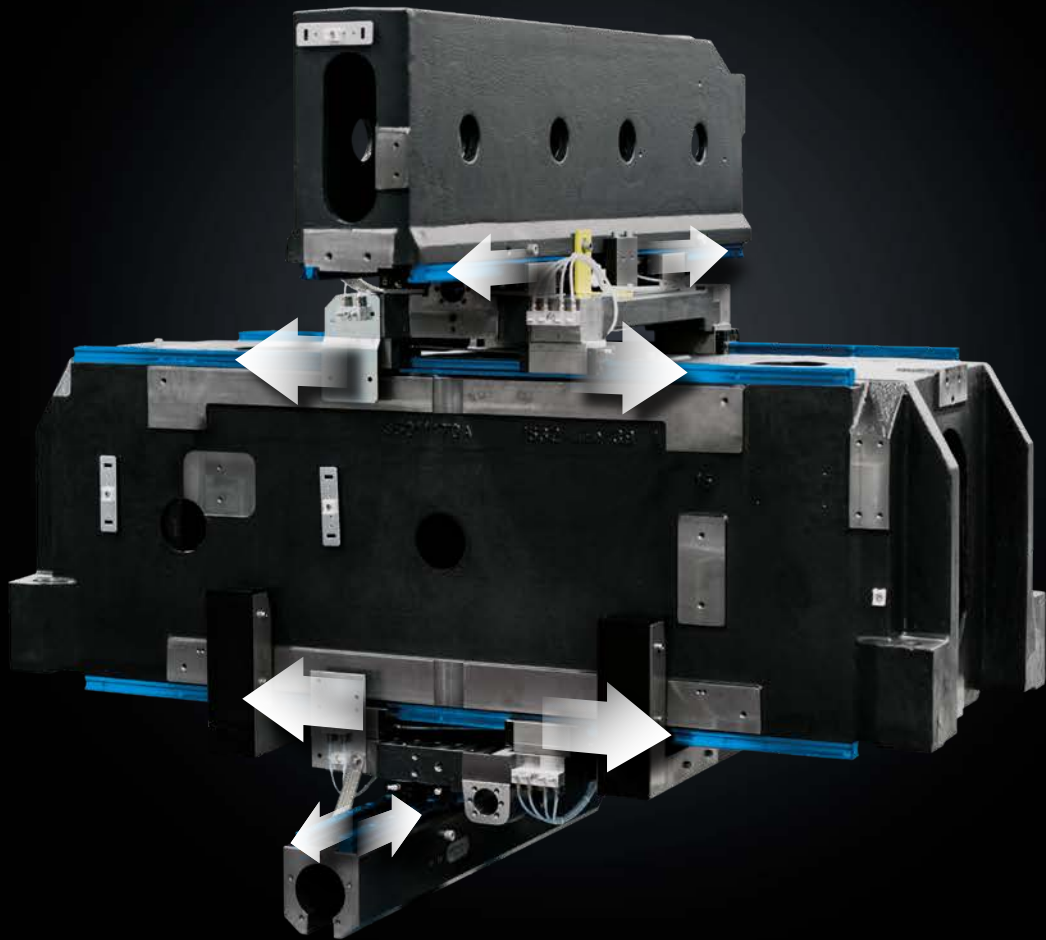

QUADRAX[®]

Benefits:

- Accommodates heavy jobs because the workpiece and dielectric liquid do not move.
- Independent U/V and X/Y axes produce precise tapered cuts.
- Creates large tapered cuts with same-sized U/V and X/Y axes.

Thermostabilization

Temperature variation is the biggest enemy of high accuracy. Even when workshop temperature fluctuates, integrated thermal regulation can maintain temperature consistently within $\pm 0.2^{\circ}\text{C}$. Accuracy and repeatability remain at their highest levels.

Available as an option on CUT P 350 Pro and CUT P 550 Pro

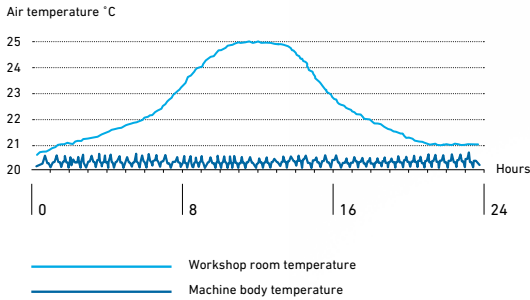

Benefits:

- Achieve high accuracy even in unstable thermal environments.

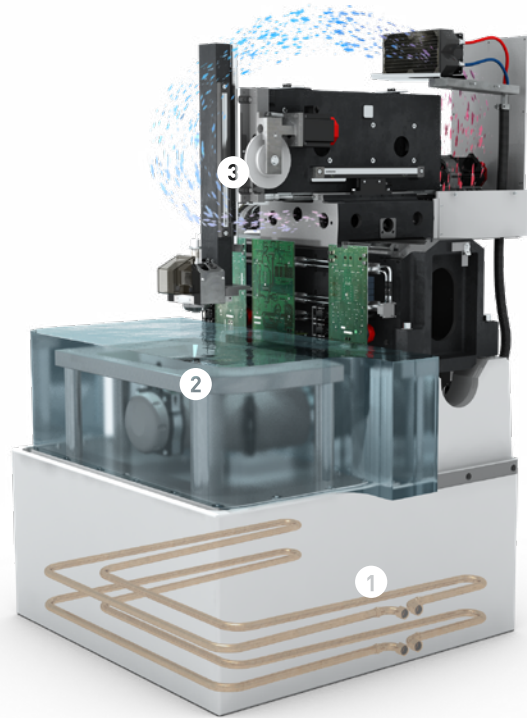

- ① Water circulation in the Rhenocast machine base
- ② Work area
- ③ Air conditioning in the machine head

Collision protection

Linear scales and rotary encoders form a double measuring system that protects the X, Y, Z, U and V axes. In the event of a collision, the system differentiates between the linear and the rotary encoder, and the energy absorber system automatically stops the axes without damage to machine or workpiece. This full protection applies at machine speeds of up to 3 m/min.

Benefits:

- High availability means no downtime after a crash.
- Protect your machine investment at low or no service cost.

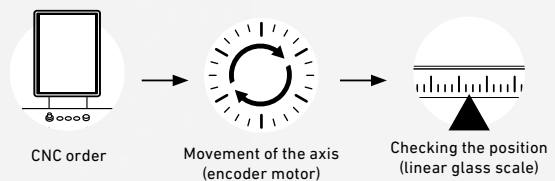

- ① Rotary encoder
- ② Linear glass scale
- ③ Energy absorber

The human interface

UNIQUA

UNIQUA is the new GF Machining Solutions human/machine interface (HMI) for wire EDM machines. It represents the pinnacle of more than a century of EDM technology – and the perfect combination of optimal functionality and usability (ergonomics) from our previous HMIs.

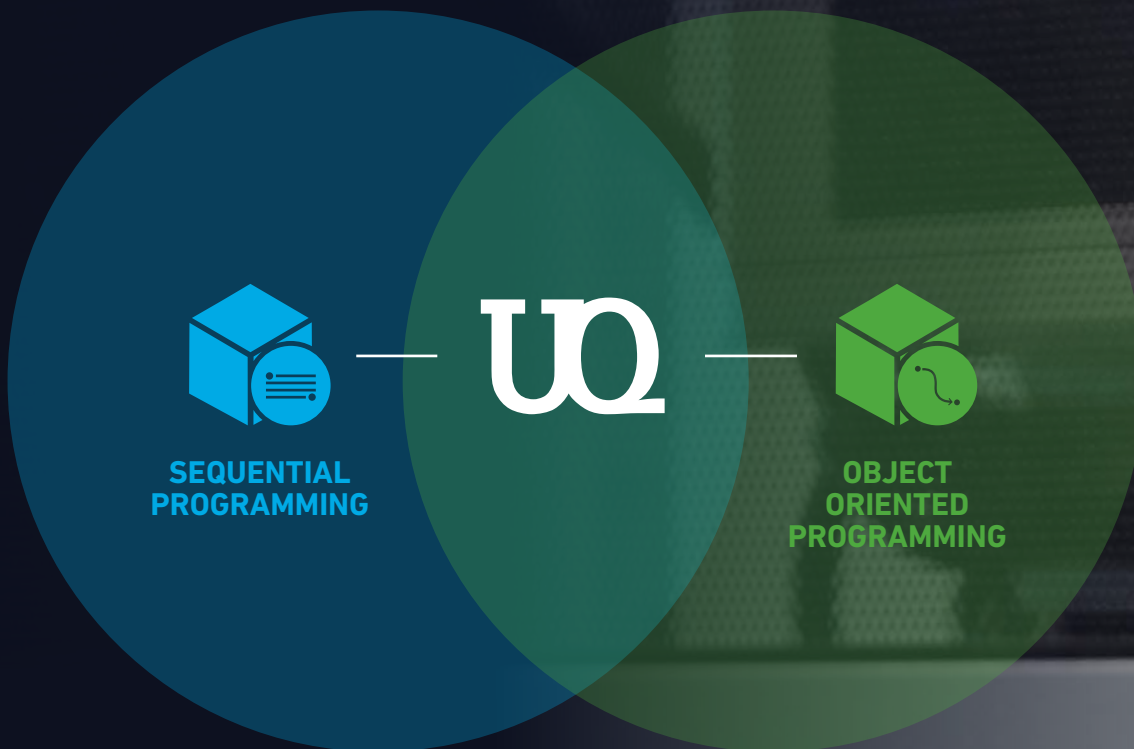

Every skill level

UNIQUA is ideal for wire EDM experts and beginners alike. While experts use its powerful functionalities, beginners can take advantage of its ease-of-use and short learning curve.

Every approach

UNIQUA works the way you want to work. Control the details of sequential programming with an updated ISO-based functionality or leverage the flexibility of object-oriented programming.

Every user

Work offline or at the machine. UNIQUA ensures compatibility with major CAD/CAM programs and also provides a powerful graphic tool with integrated CAM.

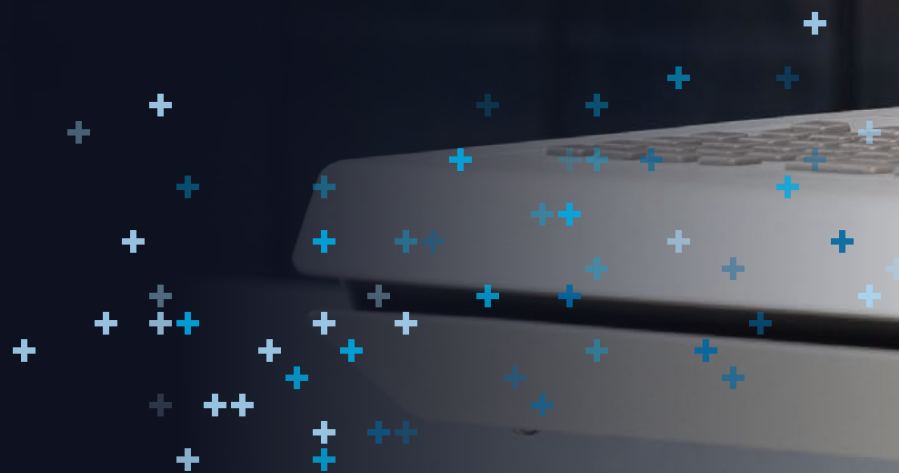

+GF+

AgieCharmilles

CUT P 550 Pro

Operator

MACHINE STATUS



CONNECTION

MANAGER

SELECTED FOLDER
RODRIGUEZ

PIECE COUNT
2

PREPARATION

CURRENTLY NOTHING IN PREPARATION

MANUAL

SELECT PROBE MODE

MACHINE	PART	MACHINING
X 200.0000	X 0.0000	X 0.0000
Y 199.0000	Y -1.0000	Y -1.0000
U 0.0000	U 0.0000	U 0.0000
V 0.0000	V 0.0000	V 0.0000
Z 80.0000	Z 30.0000	Z 30.0000
	ROT A 0.0000	ROT A 0.0000
	ROT B 0.0000	ROT B 0.0000
	ROT C 0.0000	ROT C 0.0000
	SEC 50.0000	SEC 402.9623
	REF 80.4300	REF 0.0000

EXECUTION

WORK IN EXECUTION

AUTO_BATCH
SFS STEEL H10-100 AH02 T...
SFS STEEL H10-100 AH02 T...

STATUS
INITIALIZING

TIME
00 H 00 M

NEXT INTERVENTION IN
00 H 00 M



MESSAGES



+GF+

UNIQUA

Easy to use

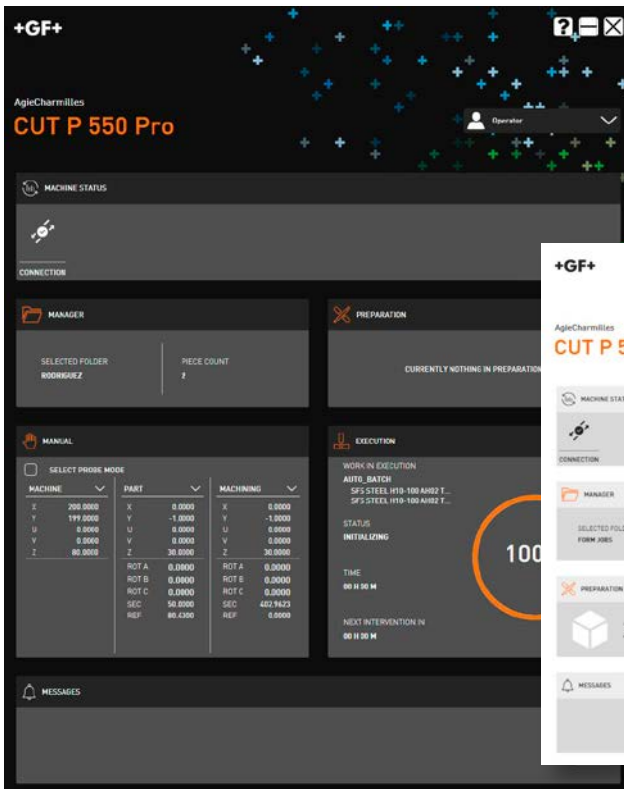

Interface innovation

Enter a new dimension of human-machine interface convenience. The new display panel provides operators with an intuitive, user-friendly 19" touchscreen that can be arranged in portrait or landscape position.

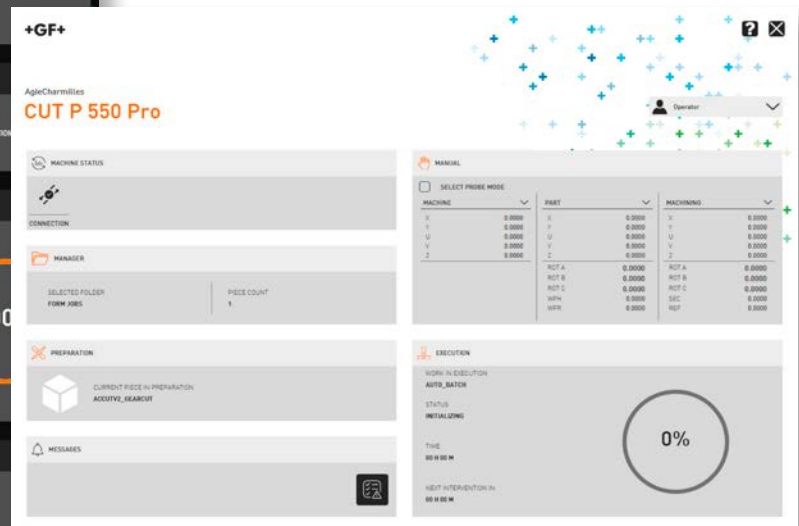

Dashboard power

Customizable dashboard widgets and easy-to-use menu system seamlessly guides you through the workflow process.

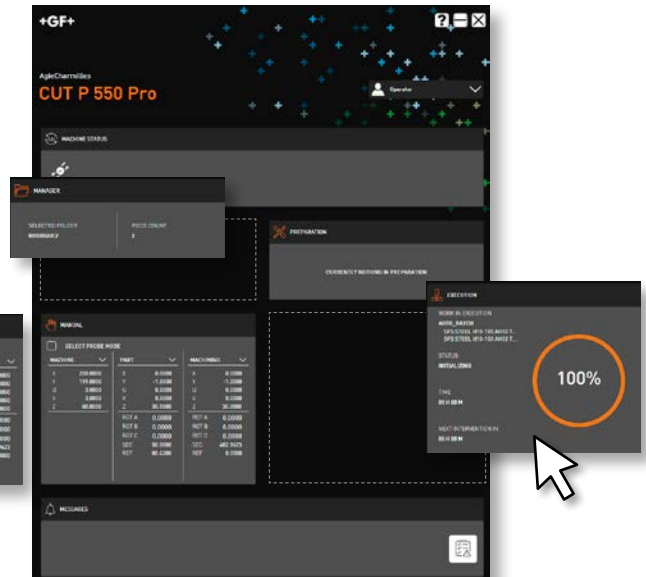
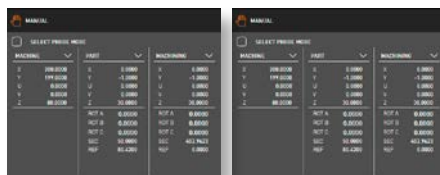

Intuitive interactivity

Shorten the learning curve and make any job easy with powerful graphic previews and an interactive help menu.

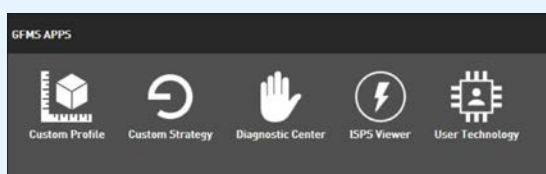

Work Space

UNIQUA tools are displayed as icons to allow for all users to easily identify key functions. GFMS applications such as Custom Profile, Custom Strategy, ISPS Viewer and User Technology, and many more, are available in two sections: Tool Box and External APPS.

UNIQUA

Where flexibility meets productivity

Flexible data input

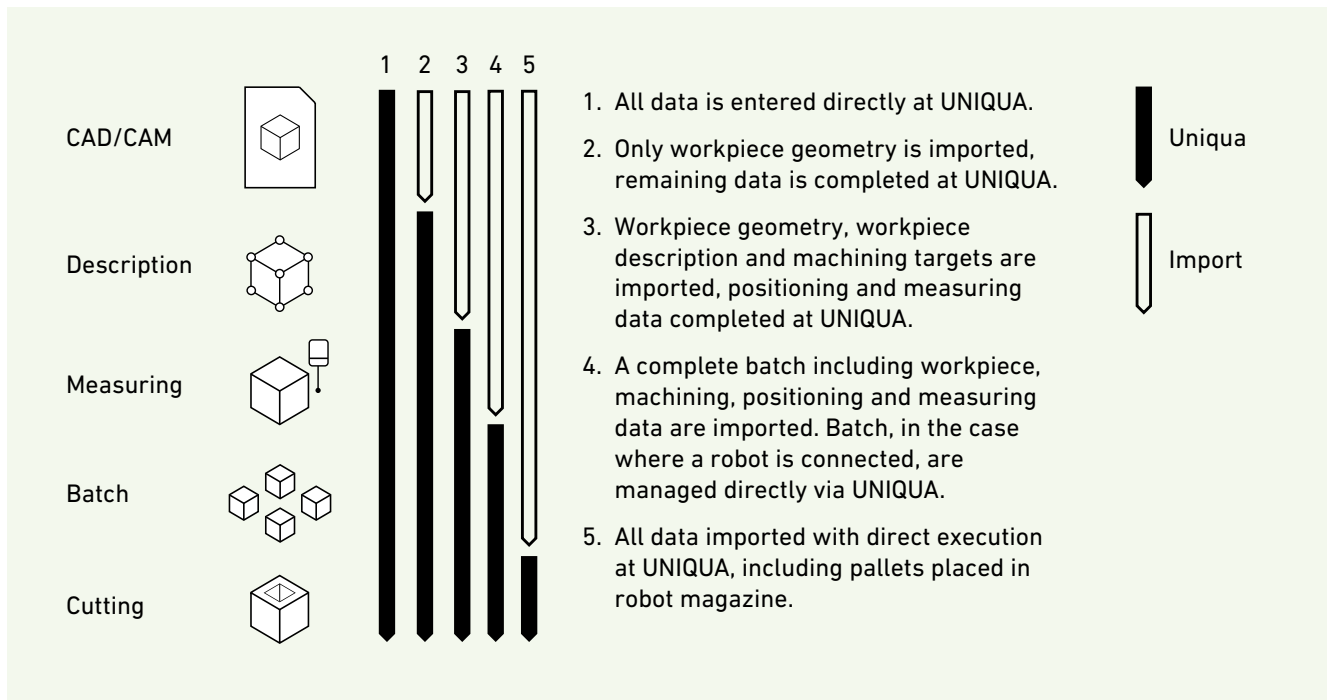

Workflow preparation

MANAGER: Manage folders, files and jobs to streamline preparation and execution.

PREPARATION: Import or create geometries, and define machining conditions, technology and sequences. 3D renderings of every job can be previewed and sent directly to execution or back to Management.

EXECUTION: The execution cockpit allows operators to configure and monitor the job with access to variables and points. The current job's operation can also be monitored graphically throughout the entire execution process.

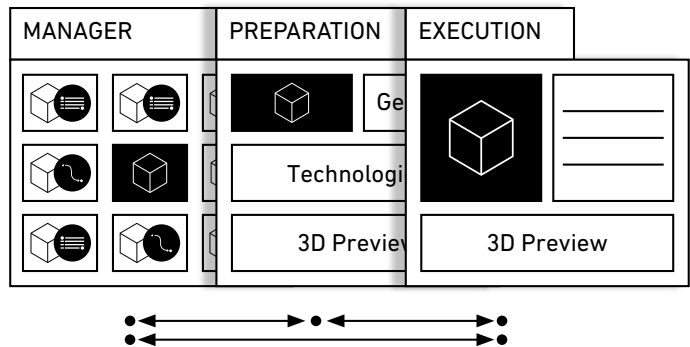

Change your working strategy at any time

UNIQUA's exclusive functionality offers you the flexibility to adjust cutting strategies anytime during preparation or execution.

Customized Strategy / Priorities

Customized machining sequences minimize unnecessary operator interventions and allow for planned downtime. Priorities can be changed during execution with "one click" directly at UNIQUA without interrupting machining.

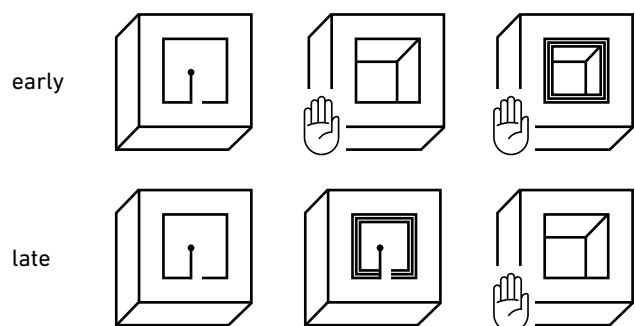

Batch management

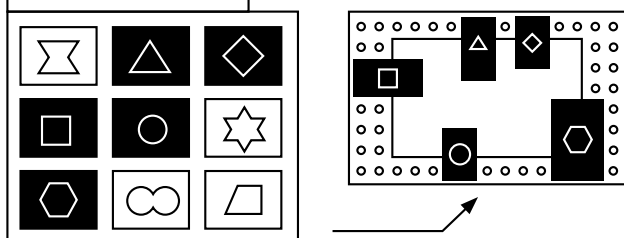

Optimized automation management

UNIQUA effectively manages workpieces by the piece, by the batch or on complete pallets. UNIQUA continuously monitors measuring and cutting processes to produce multiple pallets, which can be stored in the robot magazine. A full sequence of production in different pallets can be programmed directly from your CAD/CAM, avoiding the need of re-managing at the machine HMI.

Dynamic adaptation of batch execution

UNIQUA gives the operator full power to change workpiece and batch-execution priorities, including functions such as piece insert and priority change.

Piece insert

No loss of data or need of reprogramming when interrupting and inserting a job with Piece insert. The interrupted job is resumed exactly where it was stopped, without the need to modify existing data.

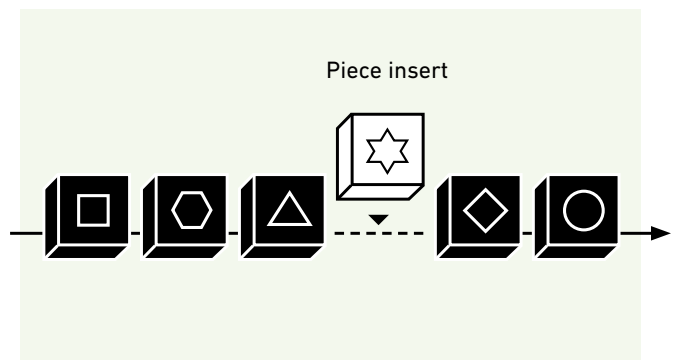

Electronic components

Accuracy is the key to your productivity

Smartphone components pack together automatically.
For fast final assembly with no gaps, all elements must be extremely precise.

Consistent surface finish
Ra 0.2 μm



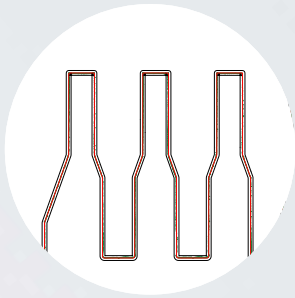
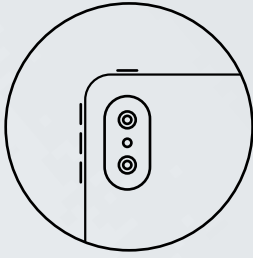

± 2 μm



Positioning and contour accuracy

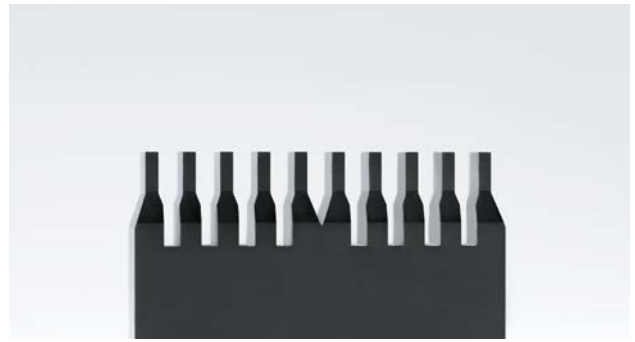

Master miniaturization

The microelectronics industry packs greater functionality into increasingly smaller spaces – and with 60 years of miniaturization mastery, GF Machining Solutions helps you create consistently precise mold inserts under any workshop conditions. With superior $\pm 2 \mu\text{m}$ positioning precision, optional thermostabilization and $70 \mu\text{m}$ diameter wire, you can make perfectly identical inserts that reproduce millions of parts.

Accelerate your productivity

To inject or stamp millions of parts per year, you need to maximize productivity and minimize the risks of failure from manual operations. With a 3D-Setup probing module or automatic slug management, the CUT P Pro series provides a fully automation-ready machining process. Add more than 8,000 hours of productivity to your annual operations with this complete solution.

Accelerate your return on investment (ROI)

Microelectronics demands blazing-fast ROI to keep up with short market cycles. We deliver a solution that's always ready to work, with smart modules that maximize consumable efficiency and maintenance planning, plus round-the-clock remote assistance from our support engineers.

Achieve low running costs

With high-volume injected or stamped parts, operating costs make a huge impact on per-part costs. Speed production with the latest, fastest process, minimized wire consumption and maximized consumables efficiency as standard features. The CUT P Pro series reduces operating costs up to 20% over previous models.

Achieve consistently high surface quality, positioning and contour accuracy.

Automotive

Optimize your workflow, reduce your time to market

Shorter times to market, larger product portfolios and zero-defect manufacturing call for shorter, more efficiency in manufacturing workflows, greater flexibility on production lines and increased process reliability. Optimize your production and overcome these challenges with the high-performance machining quality and efficiency of the CUT P Pro series.

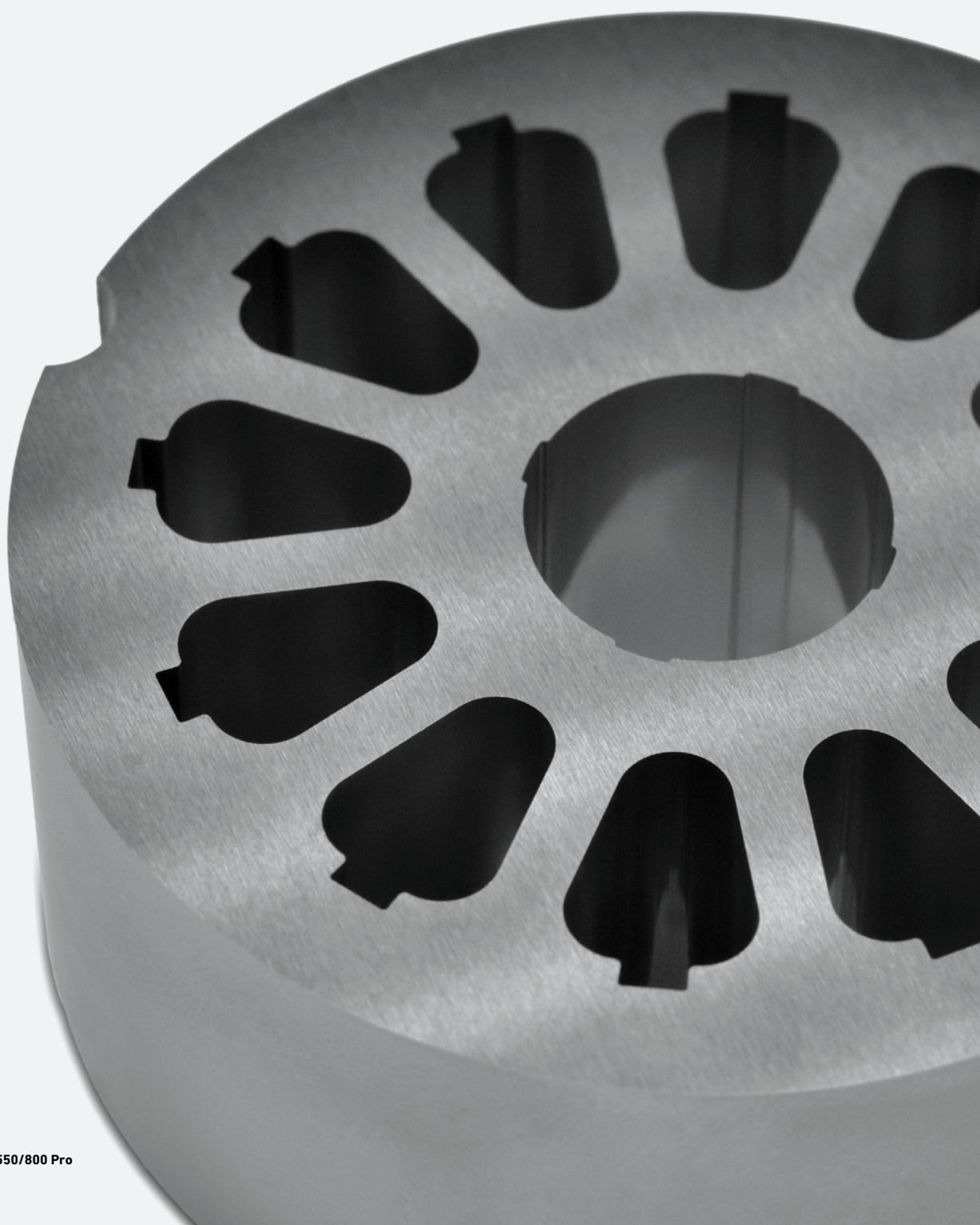

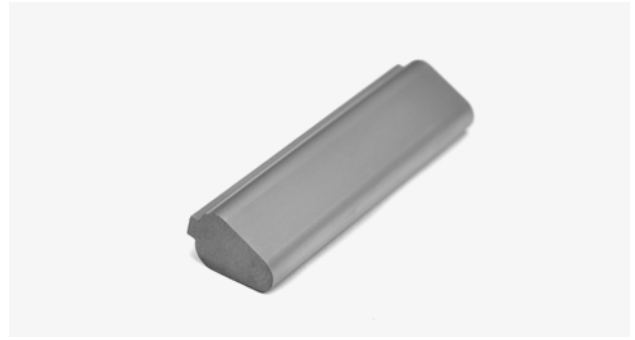
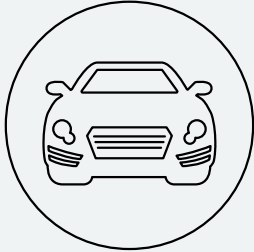

Deliver more zero-defect products faster to more customers: That's the challenge of automotive manufacturing. To succeed, you need to reduce your production steps and add more flexibility.

Lower per-part costs and increase mold lifespan

Higher accuracy, greater machining repeatability and finer surface finishes reduce your part costs and boost the life of your molds. The CUT P Pro series provides contour precision down to $\pm 2\mu\text{m}$, extreme repeatability and Ra 0.08 μm surfaces finishes, so you can achieve more cycles.

Reduce time to market

To be a preferred supplier, you need to produce high-quality products as fast as possible. The new CUT P Pro series provides the complete production solution to do just that. Increase your efficiency with tooling for part setup outside the machine, and add automation, automatic 3D Setup or workshop-management software.

Increase flexibility, reduce scrap

The market constantly demands more products, more variants – and no manufacturing defects. To master these two opposing trends, ramp up your flexibility while you reduce failure risk with the thermostabilization, advanced accuracy, and automated slug management solutions of the CUT P Pro series.

Medical

Increase your design possibilities

Contrary to popular belief, EDM offers many strong advantages over more-traditional medical industry manufacturing processes. Wire EDM easily executes complex geometries with lower production costs, no machining forces, controlled biocompatibility and wide variety of automation options.



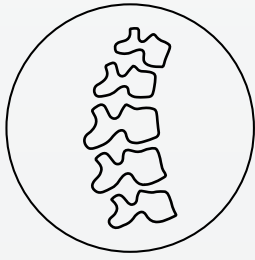

**45
degrees**

Angled EDM cuts

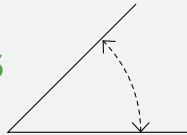

Production efficiency

Wire EDM offers you substantial advantages over traditional machining technologies with difficult-to-machine materials including stainless steels, cobalt chromium and titanium. Eliminate expensive cutting tools and deliver completely burr-free parts with any part geometry. The lack of machining forces preserves part geometries and keeps clamping very simple.

Traceability

Our CUT P Pro series conforms to ISO 13485 medical standards that mandate full traceability of the manufacturing process. Smart modules achieve total control of processes, consumables and traceability, and our rConnect module ensures a permanent connection between machine and workshop manager.

Biocompatibility

To produce implantable parts, you must manufacture biocompatible materials with perfect surface homogeneity. Our new digital IPG produces precise, fully controlled, reproducible surface integrity with no impermissible alterations of surface functionality. For full compliance with medical standards on parts including implants, machine with tungsten wire to produce uncontaminated part surfaces.

IQ Documentation Package

As the equipment manufacturer, GF Machining Solutions saves you both time and money with the option to deliver a completed IQ protocol as part of machine installation in an ISO 13485 environment. GF Machining Solutions developed this G@mp 5 compliant documentation package in close collaboration with medical manufacturers.

Packaging

Improve tool life with precise parts

In packaging and for automated packaging lines, mold makers depend on wire EDM to create functional components with great accuracy. Upholding these standards leads to longer mold life, perfect plastic injection and the creation of packaging that offers an optimal consumer experience.

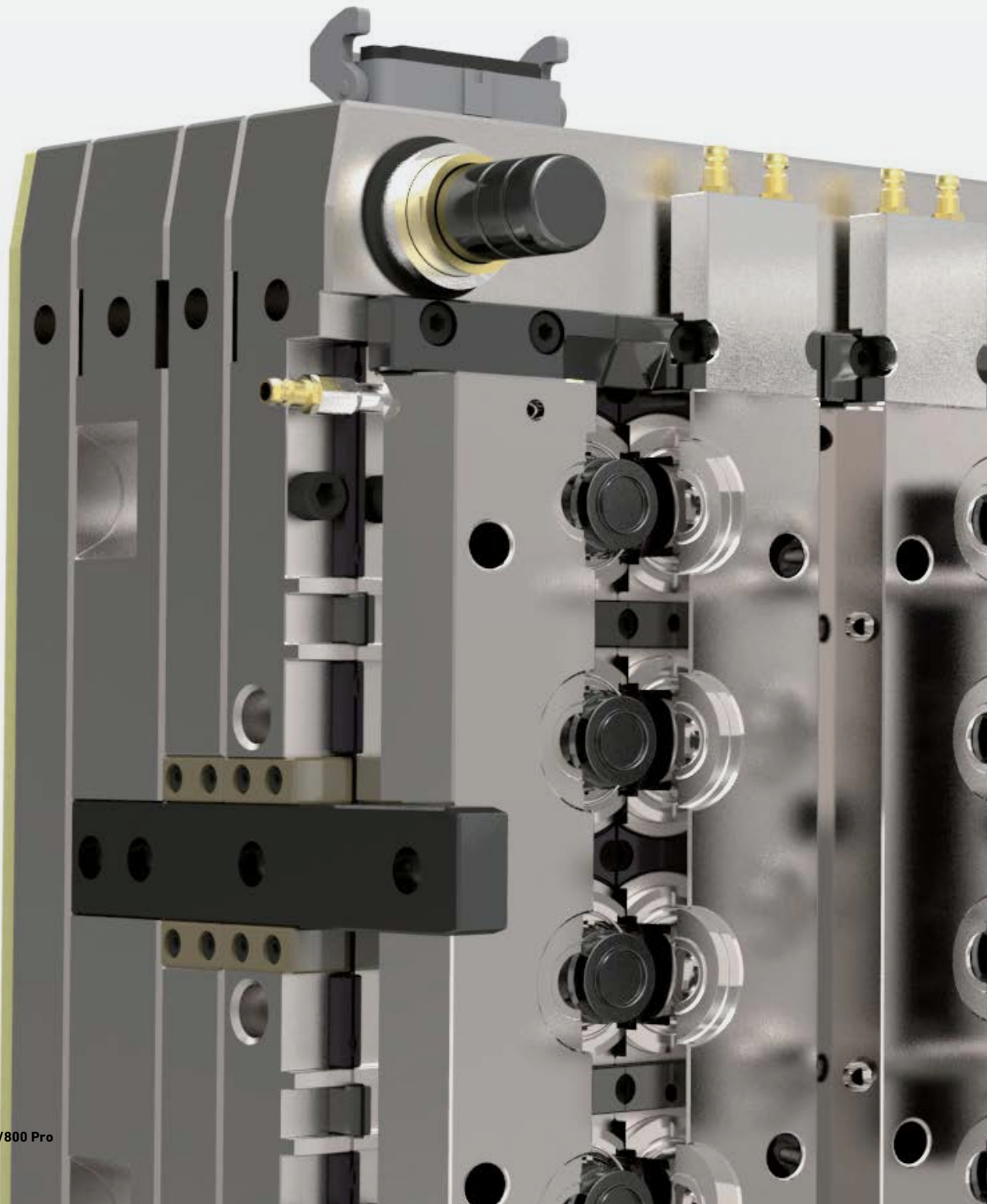



Perfect mold assemblies with guaranteed accuracy

For smooth functionality, mold components including ejector pins, guides lights, mold plates, insert slots and insert locks require extreme accuracy to produce effective assembly and smooth operations during mold injection cycles. Robust, reliable wire EDM accurately machines mold components with tight control over geometry, edge sharpness and taper.

Tool machining & maintenance cost

Today's mold makers face continuous supplier pressure to reduce tooling costs. Wire EDM technology speeds production of burr-free, accurate components and reduces the post-processing preparation for final assembly. Compared to other processes such as milling and grinding, which involve large tooling expenses, the stress-free machining of hard materials achieves high quality while it helps reduce mold maintenance and the costs of spare parts and overall production.

Meet market demands with high productivity

Continuous growth in consumer demands and choices means that mold makers must increase their production to supply large numbers of molds of various designs. To meet these demands, wire EDM with the CUT P Pro series offers high-speed machining, a powerful generator and lights-out operation for uninterrupted machining.

Sustainable EDM machining

Wire EDM helps increase the sustainability of global manufacturing. It machines tougher materials in an automation-friendly, energy-efficient process with reduced scrap rates, producing better injection cycles with new biocompatible, biodegradable plastics.



The digital brain

IPG: Intelligent Power Generator

The intelligent IPG generator with Direct Power supply module accommodates a very large range of machining systems, permitting a very high degree of precision associated with perfect surface quality and high speed. This digital generator controls the energy of each spark with great precision, providing a very fine surface quality up to Ra 0.08 μm (3 μin).



INTELLIGENT
POWER
GENERATOR

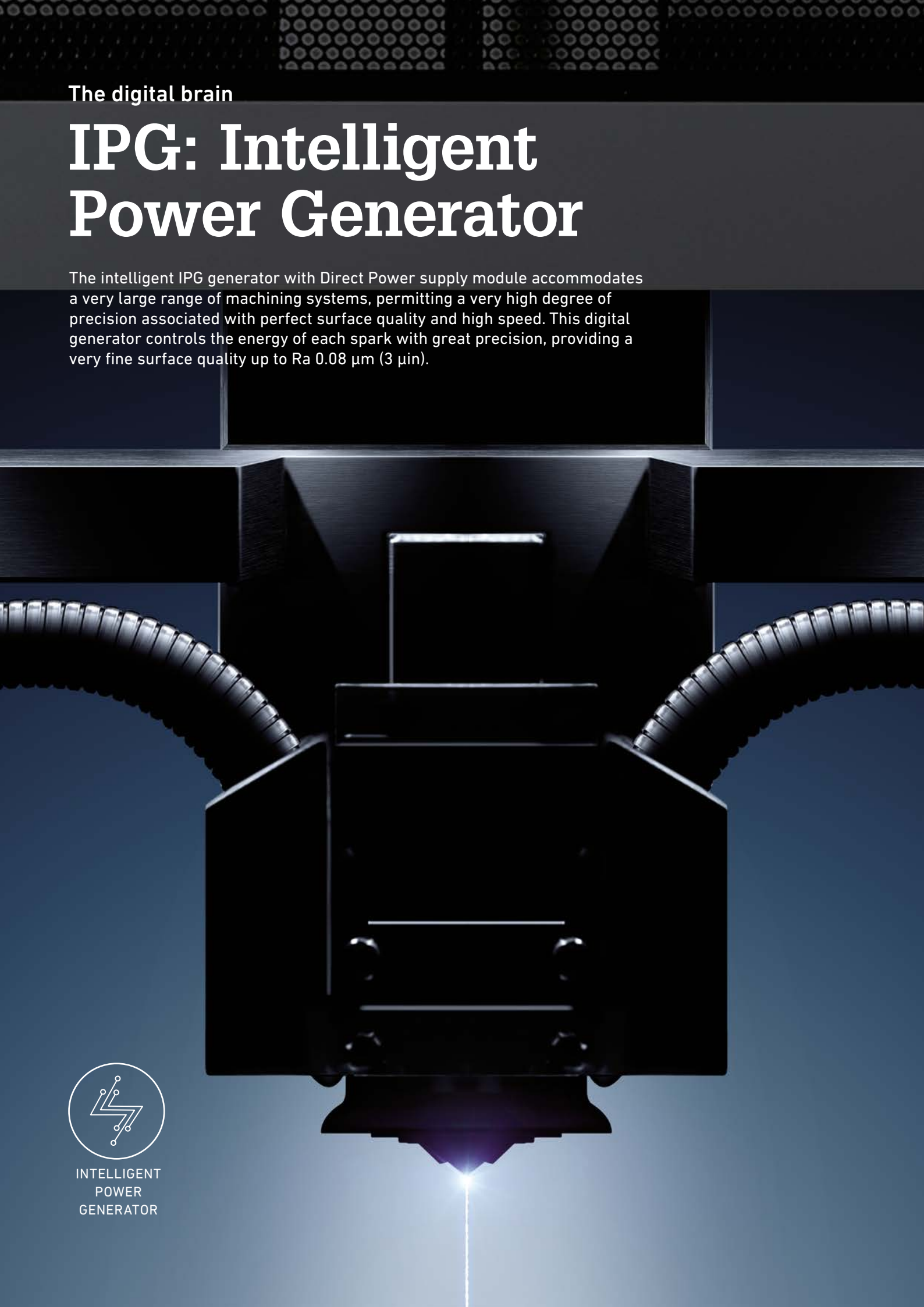



IPG MAIN FEATURES

- Spark parameter control during all production stages, especially finishing.
- Dynamic control of wire wear.
- Automatic adaptation of machining parameters to the profile during roughing and skim cuts.

IPG-DPS is conveniently situated close to the machine working area to accommodate shorter cable lengths and reduced impedances. By positioning the generator behind the work tank, the reduced distance between the power source and the sparking zone allows a much smaller impedance of the electrical circuit.

Less noise means better, faster and more accurate monitoring of your sparking process. In combination with the latest generation of central processing units (CPUs), the EDM process has better gap width control, better respect of geometry and surfaces, no wire breakage and very good speed.

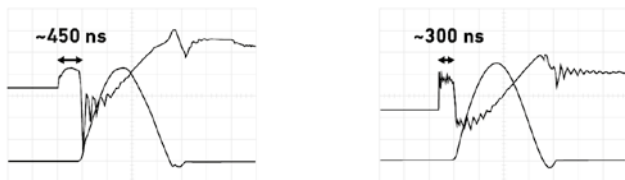

Current and voltage diagram of the sparking process showing the higher reactivity of the IPG-DPS generator.

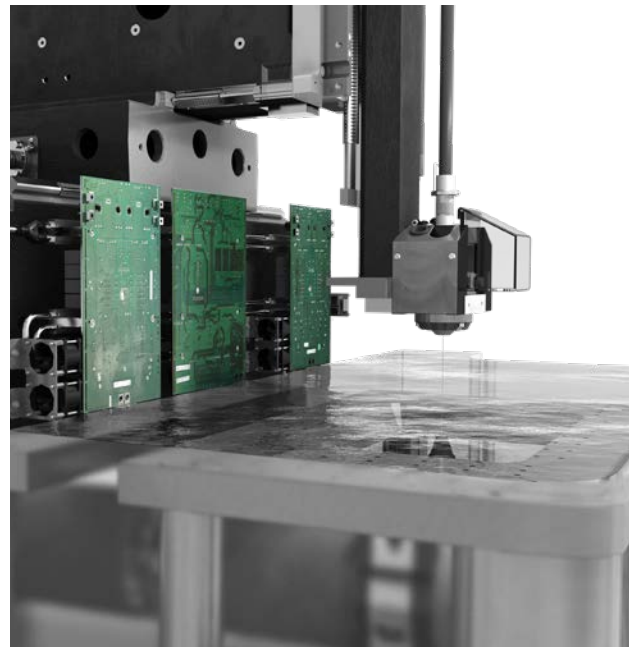

Achieve better surface finishes by overcoming complex challenges - including poor flushing conditions, risk of wire breakage and lines on the parts.

Benefits:

Obtain the finest surface finishes and minimize polishing while maintaining geometrical accuracy.

- Ensure excellent geometrical accuracy in all parts' heights.
- Gain perfect control of the fine details to ensure the highest profile accuracy.

Spark control along the wire

Spark Track

To determine spark position and monitor spark concentration, Spark Track leverages the fast, accurate signal acquisition and real time data processing from modern sensor electronics. This GF Machining Solutions innovation forms the basis of outstanding features including ISPS and iWire.

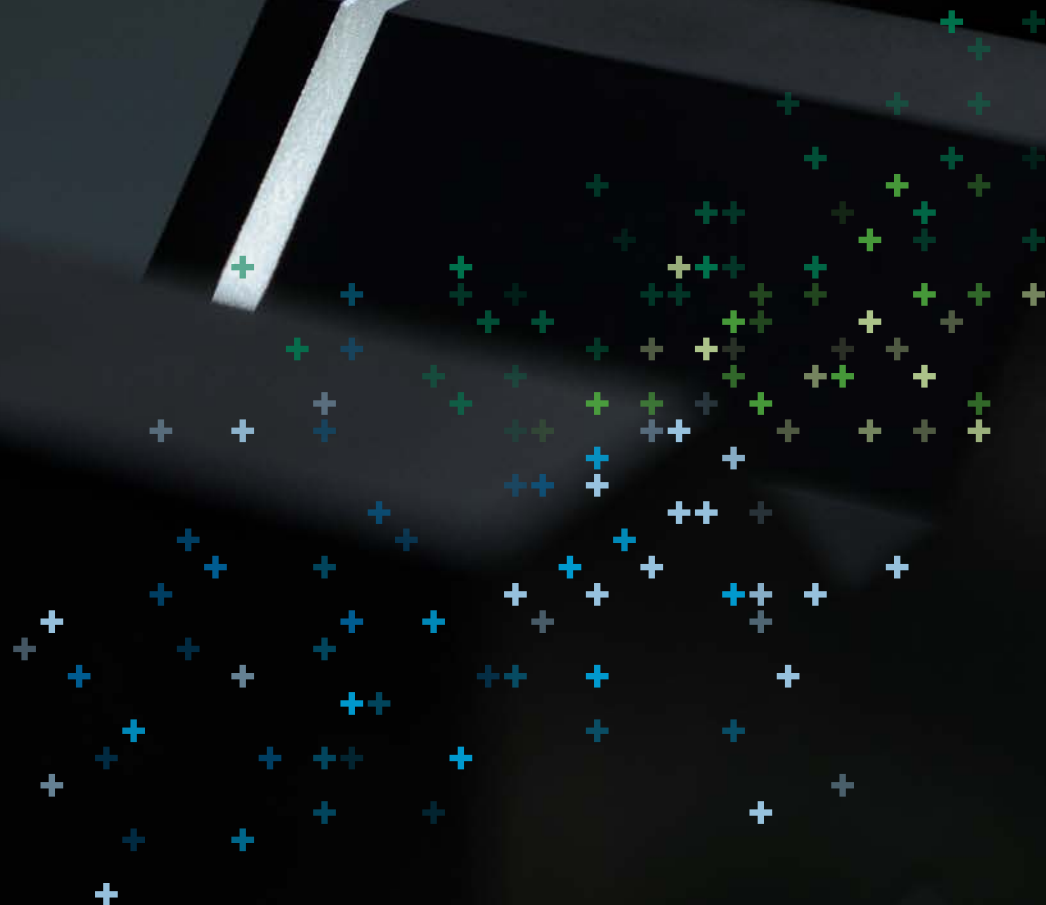
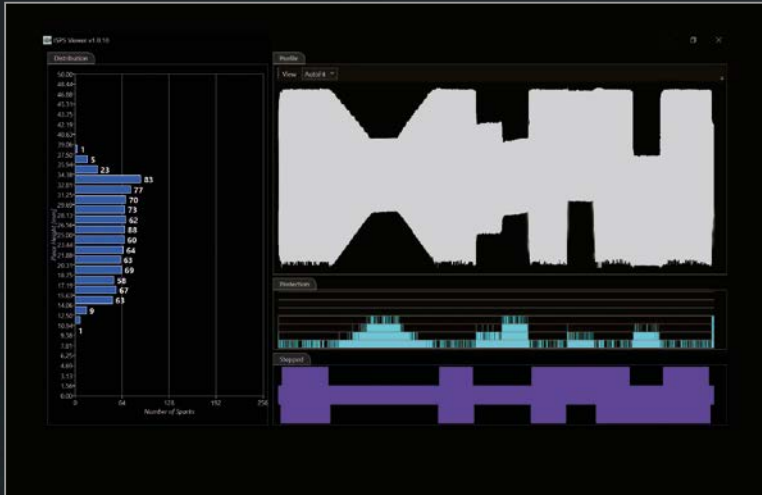

Wire breakage protection

ISPS: Intelligent Spark Protection System

To make EDM cutting easier, GF Machining Solutions' Spark Track technology includes Intelligent Spark Protection System (ISPS). Its intuitive engineering evaluates the position of each discharge between the wire and the part, analyzing the concentration against a set threshold. If the concentration exceeds the threshold, ISPS automatically adjusts spark energy in real time to prevent wire breakage and maintain optimal cutting speed.

Benefits:

- Automatic real-time parameter adjustments for variable heights, blind holes, bad flushing conditions and other extremes.
- No need for an expert operator just to avoid wire breakage.
- Elimination of wire breakage reduces idle time and enables automation.
- Increased productivity.

ISPS overcomes difficulties

- + Varying part height
- + Blind holes
- + Inclined upper or lower surfaces
- + Bad flushing conditions caused by tooling or part shape



Reduce wire consumption

iWire

Reduce wire consumption with iWire, an intelligent process based on Spark Track technology. It detects variations in the workpiece profile and adapts wire spool unwinding speed accordingly.



iWire is based on Spark Track technology that monitors the spark position and concentration. The iWire module detects the height variation of the workpiece profile and consequently adapts the wire feed speed according to the conditions.

iWire is especially effective in workpieces with high variation of height and when upper and lower heads cannot work close to the workpiece surface.

iWire is further optimized when using GF wires embedded with SMART wire (RFID) function. Knowing the wire physical characteristics, an improved technology can be applied and the wire consumption saving can increase another 20% compared to standard wires.

Benefits:

- Up to 40% wire consumption reduction
- Increase machine autonomy
- Reduce cost per part
- Reduce environmental impact

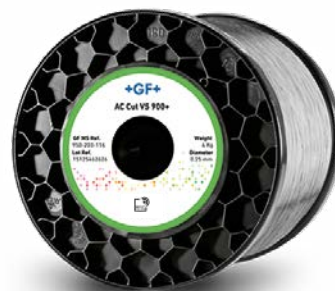

Simplify your work

Dedicated technologies

More than 600 dedicated processes to produce the best results for any need

Meet any objective with more than twice the number of dedicated processes of a standard wire EDM machine. Our CUT P Pro series includes more than 600 technologies that cover a wide range of parts from less than 1 mm to 510 mm in height, and works with materials including steel, carbide, copper, aluminum, titanium, polycrystalline diamond (PCD) and graphite. Whether you need quality, speed or cost, our complete wire range perfectly addresses your every need.

Benefits:

- Achieve reliable results with proven cutting parameters drawn from more than 100 years of experience.
- Expand your business and the range of jobs you can accept.
- With the powerful software control of UNIQUA, adopt new technologies as they emerge and when you need them.

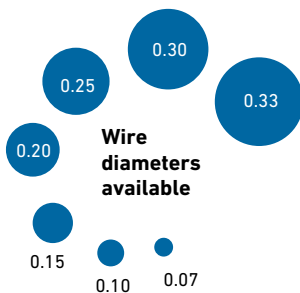

Choose your performance

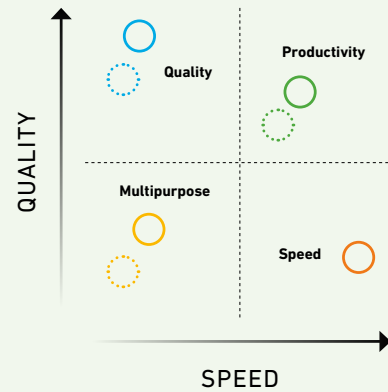

○ PREMIUM WIRES ○ EFFICIENCY WIRES



Quality
 ○ AC Cut AH
 ○ AC Cut AL

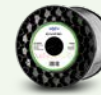

Productivity
 ○ AC Cut VS+/VP
 ○ AC Cut VL



Multipurpose
 ○ AC Brass/SP
 ○ AC Brass LP



Speed
 ○ AC Cut VH

GF Machining Solutions also offers a wire range of fine and dedicated wire for specific applications: AC Cut Micro SP-Z, AC Cut Micro A, AC Cut Micro TWS, AC Cut Molybden

Materials available



Steel



Carbide



Copper

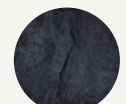

Graphite



Aluminium



Brass



Titanium



PCD

Machining heights



Unbeatable cutting speed

Turbo Tech

Our Turbo Tech cutting technologies place an intense focus on high-speed precision, up to 40% faster than any competitor's machine with better accuracy results, depending on flushing condition and geometry. Turbo Tech is available for different wire types – AC Brass, AC Cut VS+, VH and AH – and diameters.

Because Turbo Tech mainly alters trim cuts, it is fully compatible with Spark Track modules including ISPS and iWire.



	SPEED TECH	TURBO TECH
	<p>Ra achieved: 0.45 μm</p> <p>Tkm: 2.0 μm</p> <p>38 min</p>	<p>Ra achieved: 0.45 μm</p> <p>Tkm: 2.5 μm</p> <p>30 min</p> <p>21% faster</p>
	<p>Internal radius: R 0.16 mm</p> <p>TF: $\pm 2.0 \mu\text{m}$</p>	<p>Internal radius: R 0.16 mm</p> <p>TF: $\pm 2.0 \mu\text{m}$</p>

Benefits:

- Increases productivity and maintains high accuracy.
- Reduces costs per part.
- Works with ISPS and iWire to ensure process stability and reduce wire consumption even during high-speed operations.

Precise angles from 0° to 30° in 400 mm

TAPER-EXPERT

Master accuracy on small to large tapers from 0° to 30°, with 45° as an option. TAPER-EXPERT and the unique QUADRAX® design correct the wire position in real time during machining, even on the largest angles. Achieve under one minute of angle accuracy – and even below 20 seconds with complete calibration.



With its unique design and long U/V axes, the CUT P Pro series can reach up to 30° angles in 400 mm (CUT P 550 Pro feature).



To keep wire position stable and fully supported within the guide when the machine is moving, closed diamond guides allow only $\pm 2 \mu\text{m}$ clearance between wire and guide.

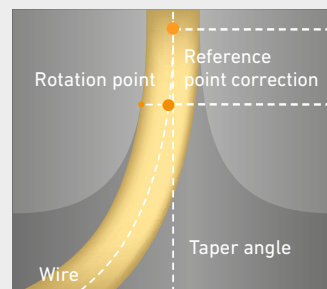

TAPER-EXPERT compensates head position in real time during machining depending on the angle.

Benefits:

- Unmatched taper accuracy.
- Large range of applications.
- Accurately tapered surfaces increase injection-mold tooling life.



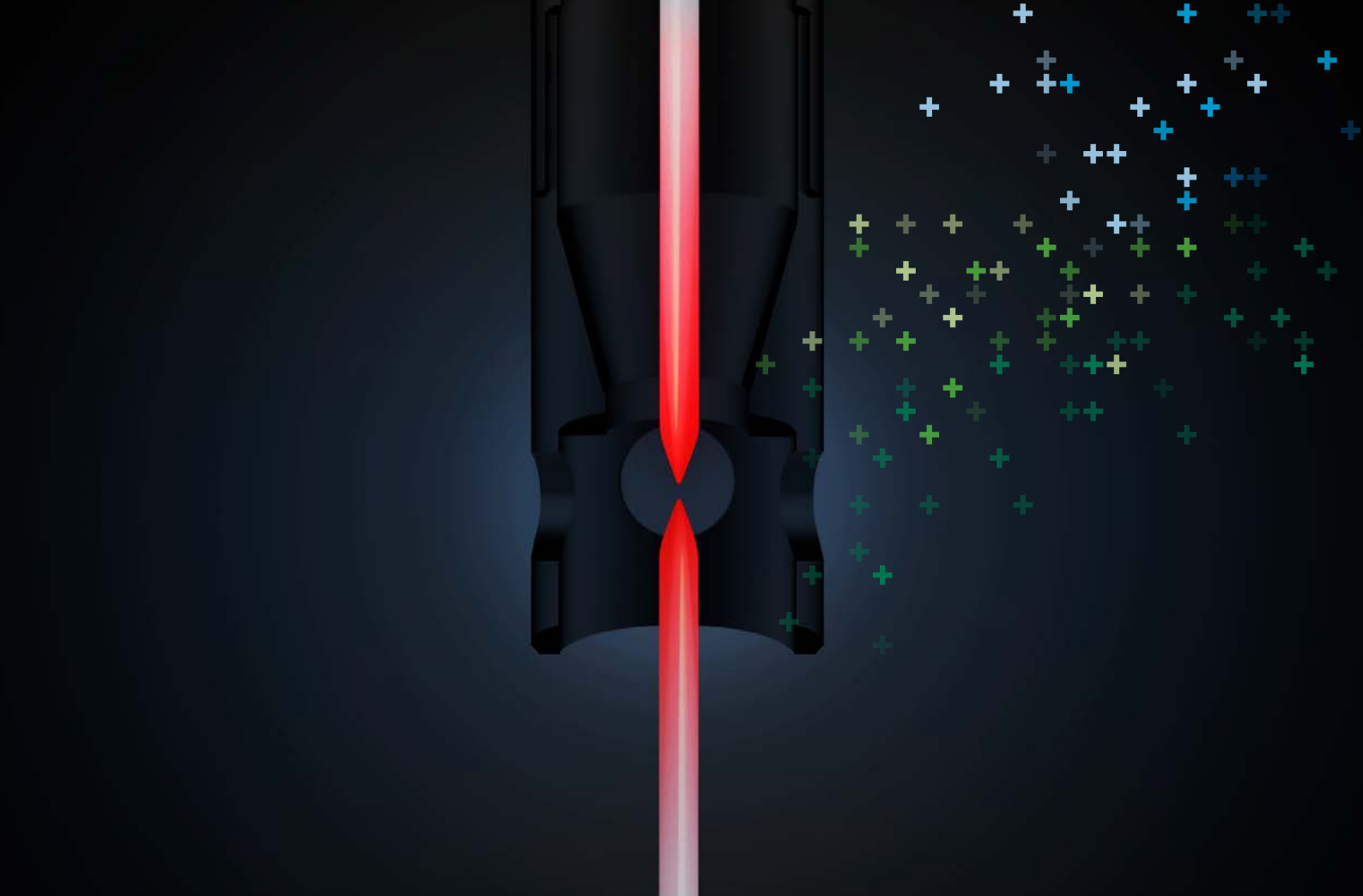

Reliable threading and re-threading with annealing

AWT: Automatic Wire Threading

For proper unattended machine operation and automation, reliable automatic wire threading and re-threading is essential.

Wire annealing

Automatic Wire Threading heats the wire between the brake and the lower working head, then chills it with a jet of air and stretches it to reduce its diameter, annealing and extending the wire to a specific length. This produces burr-free thermal cutting and a conically shaped end that is easy to insert through the guides and the workpiece.

Benefits:

- Ensure job processing with correct rethreading even under the most difficult conditions.
- Automatically cut multiple openings in die blocks and progressive dies during unattended operation.
- Enable smooth automation implementation.

A new era of autonomy

ASM: Automatic Slug Management

For the first time, the wire EDM process is completely autonomous. By automating conventional slug extraction, which represents up to 20 percent of total processing time, you can reduce manual intervention and get back to work faster.

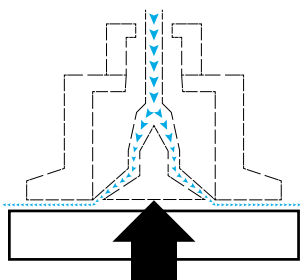

Bernoulli effect

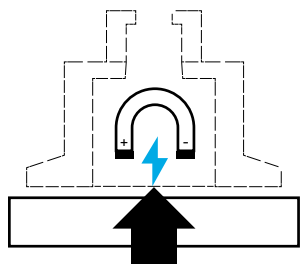

Magnetic

Choose from two different on-demand technical solutions – Bernoulli or magnetic – and cut processing time by up to 20%. The system removes pieces after the cutting stage.

Productivity, part cost and flexibility are your top priorities — and our slug management solutions can cut your processing time by up to 20 percent. From conception to complete installation — and beyond, GF Machining Solutions stands ready to support your objectives with a world-class production solution.

Benefits:

- Enable 100% automation
- No need for day and night strategies
- Lower operator presence time
- Faster processing time

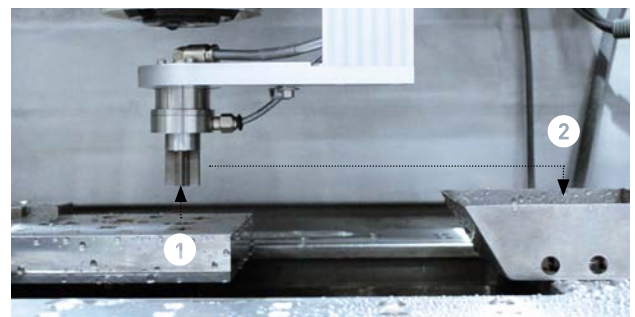

Slug removal: 1 aspiration, 2 move and collect in a bin

Decoupling manual intervention

ASW: Automatic Slug Welding

The new Automatic Slug Welding is an easy to configure functionality that automatically welds the core to the cavity, leaving a microfixture using a reverse erosion process.

This allows you to easily remove the core by a manual tap before the finishing cuts and reduce processing time by up to 10 percent and manual intervention time by up to 90 percent.

Benefits:

- Enable 100% automation
- Faster processing time
- Reduce manual interventions
- No need for day and night strategies

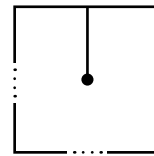
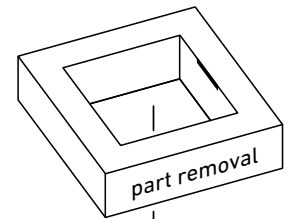
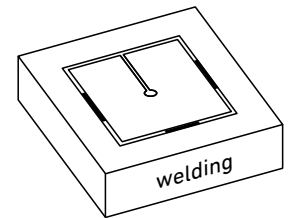
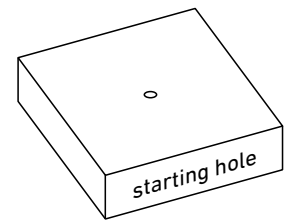

ASW

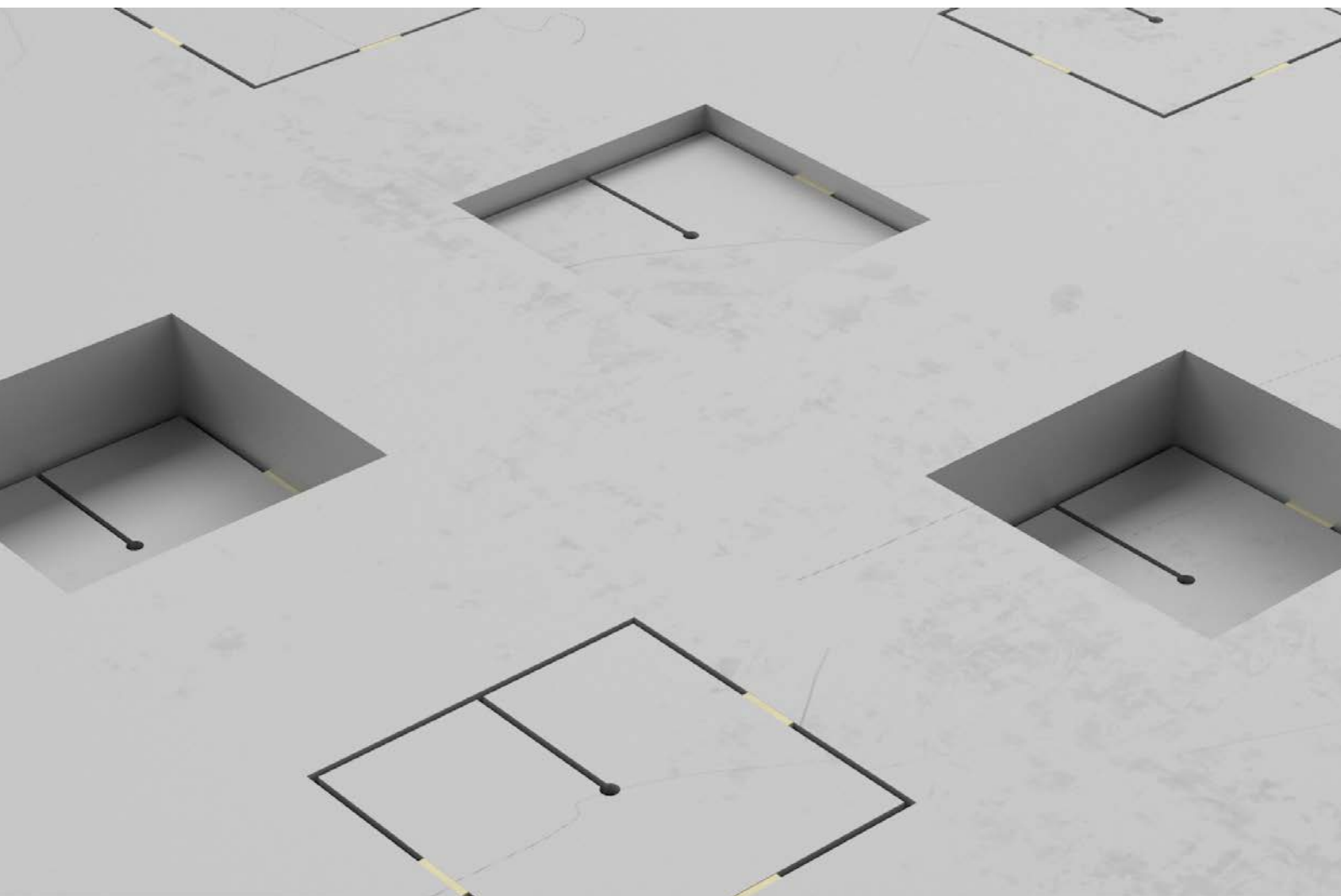
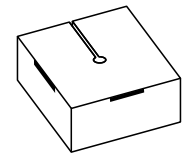

Tailor-made solutions for your business

System 3R Tooling Automation and software

Accommodate production changes and maximize your throughput with tooling and automation solutions that match your business and your operating environment.

Precision tooling

Increase machine spindle time and your business productivity when you convert internal setup to external setup. Minimize set up time in the machine with our reference system.

Tooling enables you to place raw material on a reference element (pallet) and preset the assembly on an external station. When you put the assembly on the machine chuck, the reference element matches with a repeatability of less than 2 µm. Load a preset data file into the machine and limit chip-to-chip time to pallet loading time.

Gain up to +50% productivity in a single-shift workshop.

Work smarter, not harder.

Scalable automation

Automation keeps your production going around the clock and throughout the week. Unattended production becomes a reality with night shift on weekends and during holidays.

After you fill a WorkPartner 1+ compact robot with raw materials, it can feed up to two wire EDM machines for more than two days without touching the automation cell.

The results? Shorter lead times, higher productivity and quicker payback of your capital investment.

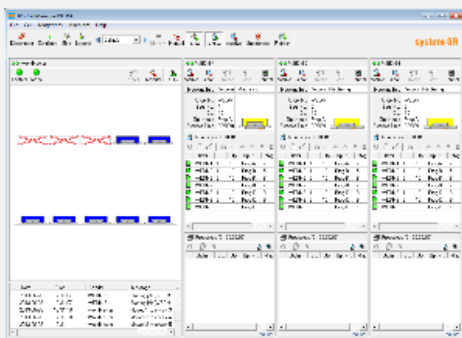

Cell management software

Boost your competitiveness while you give your shop complete autonomy and flexibility with cell management software. The WorkShopManager software suite easily manages your complex automation cell – with various technologies and workpieces cross flows – from a single computer. Easily change priorities and receive all your production data. The cell reacts to any problem, adapts production, carries out all machinable jobs and sends messages to the operator.



Select the best System 3R robot for your workflow

System 3R robot

Weight on the Delphin Short WEDM frame¹

Transformer WorkMaster

Easy-to-manage 3-axis polar robot, for up to 12 machines

up to 125 kg

Transformer 6-axis

Flexible anthropomorphic robot, for up to 12 machines

up to 150 kg²

1. Weight on the frame = weight of work piece + weight of the clamping bars.
 2. Maximum weight on the frame to guarantee the best repeatability.
 Always ask to the System 3R Automation Specialists and Sales Support for a dedicated review of each specific case.

Benefits from frames

- External preset: save setup time.
- Load automatically into the machine.
- Exploit the full cutting area.
- Use with 1-12 machines.
- Drying-unit ready.
- Operate around the clock with automation.



Availability is the key for your business

Connecting you to the future

Industry 4.0

GF Machining Solutions' die sinking EDM aligns completely with Industry 4.0 and your need to optimize production processes through intelligent use of data. We understand where machines fit in the bigger picture of creation, simulation and post-processing stages. That's why we collaborate with multiple partners to connect all the stages and make them complementary.



OPC UA Standard Interface for 3rd-party usage

One connectivity solution for all machines



OPC UA Standard Interface and its plug-and-play capabilities make it simpler than ever to connect your GF Machining Solutions machines to existing 3rd-party applications such as ERP, MES and Dashboard.

Main contents

- Machine identity
- Machine states
- Process and job Information
- Machine messages
- Precomputed KPIs

+ **Shorten engineering time**
Ease integration for 3rd party usage and reduce integration costs.

+ **Achieve competitive advantages**
Enable seamless data exchange between machines and any software.

+ **Improve productivity**
Rapidly identify potential productivity improvements with ready-to-use pre-computed KPIs.

+ **Ensure data integrity**
Maintain safe, securely encrypted data communication through username/password access.

SMART wire



GF Machining Solutions SMART wire enables you to use your wire EDM machine to its full potential and achieve Industry 4.0-level process control. SMART wire spools store wire characteristics and traceability-related data on radio

frequency identification (RFID) chips. This system monitors remaining wire length to avoid unexpected interruptions and checks the wire loaded on the machine to ensure correct use every time. Wire data in machine reports enhances traceability.



rConnect

Secure the highest availability of machine intelligence

rConnect brings smart manufacturing to your shop. Operate at your full potential with innovative applications that make machine intelligence available all the time.

Benefits

- Obtain detailed production information with a dedicated rConnect cockpit for each machine.
- Increase your uptime.
- Gain direct, interactive access to our service specialists.
- Quickly identify potential problems.
- Maintain secure connections based on the latest technology – certified by TÜVIT.
- Increase your efficiency with a significant step toward smart services.



rConnect Live Remote Assistance

Connect remotely to our expert engineers, who respond rapidly to your service requests in real time.



rConnect Messenger

Receive machine data directly on your mobile device. Monitor your machines continuously to gain insight into the efficiency of your shop.

Sustainability

Focus on energy efficiency

Our new generation of Wire-Cutting machines proved achieving a reduction of 30% of the daily energy consumption, compared to the previous generation.

This improvement has been made possible thanks to the smart module Econowatt during standby mode, and, during operating mode, thanks to the latest generation of GF Machining Solutions' Intelligent Power Generators (IPG) and to new injection pumps.



Energy Efficiency Certificate



Operating mode (24-hr. cycle time)	CUT X00 series (2015)	CUT P series (2020)	Energy saving %	GF enhancements (see below)
Standby (4h)	2.7 kW	0.3 kW	-89%	1
Ready (4h)	2.75 kW	2.75 kW	-	-
Machining (16h)	5.25 kW	3.85 kW	-27%	2,3,4,5
Daily Energy Consumption	105.8 kWh	73.8 kWh	-30%	

Measurements made on CUT 300 and CUT P 550 in accordance with measurement standards as defined in ISO 14955

1 // Econowatt

Smart module enables energy-saving standby mode and programmable fast reactivation ("wake up") option. No energy waste during non-productive time, and the equipment is ready to run every morning.

2 // IPG – Higher electrical efficiency

The latest generation of GF Machining Solutions' Intelligent Power Generators (IPG) provides fast digital control of each spark to improve the machine's electrical efficiency.

3 // IPG – Reduced energy waste

IPG's resonant switching mode helps reduce energy waste.

4 // IPG – Reduced component wear

IPG reduces component wear throughout the lifecycle of the machine.

5 // Injection pumps – Higher energy efficiency

Replacing high-pressure pumps with injection pumps reduces energy consumption.

Over 1 year, equivalent to greenhouse gas and CO₂ emissions from:



719,820
smartphones
charged



carbon sequestered by
97
tree seedlings
grown for 10 years



23,934
kilometers driven
by an average
passenger car

Source:
www.epa.gov

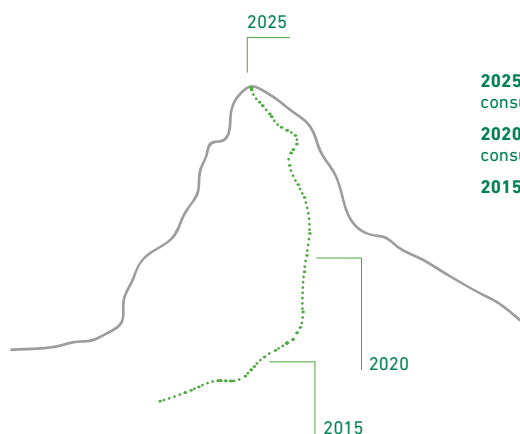

2025 // 45% reduction of daily energy consumption

2020 // CUT P Pro series: Daily energy consumption reduced by 30%

2015 // CUT X00 series

Academy

Manage the full lifetime of your machine

The continuing availability of your AgieCharmilles CUT P Pro serie machine, your productivity, and your continuous improvement—such as operator knowledge, machine upgrades or preventive maintenance—are essential to keeping your business successful.



Our expertise at your service

The GF Machining Solutions Academy has the remarkable, human-centric mission of managing the knowledge transfer from Research and Development, Customer Services and sales and application support all the way through to our innovative training.

Knowledge is key in manufacturing today, as topics, capabilities and training itself are changing. The Academy facilitates the knowledge transfer that is key to exploiting the full capabilities of your GF Machining Solutions Electrical Discharge Machining (EDM), Milling and Laser machines as well as Automation. You benefit from more than 1,000 years of accumulated expertise across five technologies—at your service.

Training is a must

From basics to performance, we propose first “Learn to operate” modules that aim to take your operator to the appropriate skill level for becoming certified and up to speed on the safe use of your AgieCharmilles CUT machine. Upon completion of the “Learn to operate” module, you’re ready for the “Maximize performance” training modules that increase your knowledge by focusing on more complex parts, design and surface functionalities.

Dedicated to your operator, EDM-Wire-Uniqua module are your manufacturing must-have for starting and efficiently using your AgieCharmilles CUT machine. They deliver measurable added value for your operator—and your business—and lay the foundation for exploiting 100% of your machine’s capabilities.

To learn more about GF Machining Solutions Academy training opportunities, please visit www.gfms.com/academy.



Discover the limitless possibilities of your CUT P Pro series machine

What are the course contents ?

- + Specifications of Wire EDM Process
- + Security
- + First machining approach
- + Uniqua interface overview
- + Coordinate systems
- + Machine options
- + Basic maintenance

What is the course objective ?

- + Know all the possibilities of your machine to become more productive
- + What are the course benefits ?
- + Become autonomous on basic use with machine
- + Maximize your productivity through basic parameters
- + Optimize your use of consumables



Our Service + Success range

We take you to new heights

Guiding your ascent

Whether it is Milling, EDM, Laser Texturing or Additive Manufacturing, our Service + Success experts guide you throughout the entire lifecycle of our Machining and Automation tools in order to help you reach your peak performance. Our trusted experts backed by our latest cutting-edge, intelligent Digital Solutions, provide a **full range of services**.



Operational steering
Hands-on and operational service interventions with supply of consumables and wear parts



Advanced diagnosis
Machine check-up, preventive maintenance and advanced services including original spare parts availability in all our hubs around the world



Certification
State-of-the-art reference by industry sector and on machining equipment



Upgrades
Designed to add value to the original machine investment in order to achieve higher sustainable productivity



Training
Performance oriented academy with a human-centric approach of knowledge transfer in order to realize the full potential of our solutions



Transformation
Strategic partnership from made-to-measure advice on business model evolution to industrial implementation



Financial solutions
For the optimization of operating costs featuring minimal initial expenditure programs and leasing options

Our Success Packs

As a long-time partner, since 1802 we have been serving various industrial segments and have been dedicated to providing you with a first-in-class combination of services.

We have conceived our new Success Packs range for maximizing **your return on investment**, empowering you in your quest for success whatever your industrial profile.



Silver +
Secure
your future



Silver
Set the foundation
for growth



Bronze +
Achieve flawless
production



Bronze
Get back on
track fast



Available options



1 // Chromium-hardened table

The clamping table features a special chromium anti-scratching surface treatment, and incorporates 108 M8 holes distributed in two rows around the table with a 50 mm pitch.

2 // Advanced accuracy

A special procedure applied during the machine's final geometry and mechanical-control check performs calibration with a 19-hole plate crafted after the build to verify positional accuracy.

We fine-tune axis calibration through several iterations based on the result of the positional accuracy check. This procedure achieves pitch accuracy of $\pm 2.0 \mu\text{m}$.

3 // Renishaw 3D probing system

Choose the fixed or retractable Renishaw mechanical touch probe option to measure the planarity and position of workpieces placed on the machine's worktable. To use the probe, insert it manually into a chuck on the left side of the Z axis.

4 // Big spool unit (25 kg)

Accessible from the left side of the machine, this option enables you to:

- Increase machining autonomy up to 100 hours (wire $\varnothing 0.25 \text{ mm}$).
- Accommodate DIN K200 (16 kg), K250 (25 kg) or JIS P15 (15 kg).

5 // Surge Protection Device (SPD)

To reinforce protection against HPS breaks beyond the standard main filter with integrated protection, choose the optional additional SPD.

6 // Automatic centralized greasing

To ensure long-lasting mechanical function, the CNC automates manual centralized greasing via an electrical pump. The central lubrication system, located between the electrical cabinet and the D8 filters, lubricates all the machine's axes, including X, Y, U, V and Z. This system uses specific distribution movements to facilitate access to and lubrication of the guides and ball screws.

7 // 3D Setup

Measure the planarity of workplaces on the machine tool's worktable with the mechanical touch probe of the factory-installed workpiece alignment sensor (3D Setup). Located on the left side of the Z axis, this probe extends automatically for measurements. The full 3D functionality of this feature enables you to place the wire perpendicular to the upper face of the part automatically during part setup. Because this function not only defines wire inclination but also operates rotation in the space of the machine's coordinate system, this alignment function – called 3D correction – makes the precise position of the part planes on the Z axis precisely known.

8 // Wire chopper

The wire chopper cuts used wire into small chips and collects them into a box at the back of the machine that holds up to 25 kg of brass. Note that because the wire chopper is integrated fully into the machine, it does not change the machine dimensions.

9 // Four-color stack light

To visualize equipment status, the optional stacklight incorporates four configurable colors: green, yellow, red and blue. Order this stacklight with optional WD0188 I/O interface.

10 // Horizontal manual wire annealing

To use this wire-annealing system, the operator positions the wire horizontally. A conveniently placed button assists the operator in annealing the wire to prepare for threading.

11 // Auxiliary rotary axis (with/without chuck)

The rotating/positioning Spindle is completely sealed against liquid and can be used horizontally in the dielectric of electrical discharge machines.

The measuring system is situated on the rotary table axis for direct measurement. This axis is able to do indexing, spinning and turn while burn (TwB).



EXN 0-005
+ BALLUFF M11
+ B12014J
+ B15 M-005-0007-04 200710

Technical specifications



CUT P 350 Pro



CUT P 550 Pro



CUT P 800 Pro

		CUT P 350 Pro	CUT P 550 Pro	CUT P 800 Pro
Machine				
Type of machining		Submerged wire cutting	Submerged wire cutting	Submerged wire cutting
Dimensions of complete equipment (*)	mm (in)	2050 x 2234 x 2154 (80.71 x 87.95 x 84.80)	2600 x 2640 x 2340 (102.36 x 103.94 x 92.13)	2670 x 2870 x 2645 (105.12 x 112.99 x 104.13)
Total weight of equipment (without dielectric)	kg (lbs)	2450 (5401)	3300 (7275)	6300 (13860)
Machining area				
Vertical sliding door		Automatic	Automatic	Automatic
Max. workpiece dimensions (*) (Top load)	mm (in)	1000 x 150 x 220 (39.37 x 5.90 x 8.66)	1200 x 275 x 400 (47.24 x 10.80 x 15.75)	1450 x 550 x 510 (57.08 x 37.40 x 20.07)
Max. workpiece dimensions (*) (Front load)	mm (in)	800 x 550 x 220 (31.50 x 21.65 x 8.66)	1000 x 700 x 400 (39.37 x 27.56 x 15.75)	1450 x 950 x 510 (51.08 x 21.65 x 20.07)
Max. workpiece weight	kg (lbs)	750 (1653)	1500 (3307)	3000 (6614)
Dimensions of table (**)	mm (in)	680 x 450 (26.77 x 17.72)	900 x 600 (35.43 x 23.62)	1240 x 800 (48.8 x 31.5)
Floor-to-table distance	mm (in)	1000 (39.37)	1000 (39.37)	1000 (39.37)
Total volume of dielectric fluid	l (gal)	700 (185)	1300 (344)	1700 (450)
X, Y, Z and U, V axes				
X, Y, Z travel (*)	mm (in)	350 x 220 x 220 (13.77 x 8.66 x 8.66)	550 x 350 x 400 (21.65 x 13.77 x 15.75)	800 x 550 x 510 (31.5 x 21.65 x 20.07)
U, V travel (**)	mm (in)	350 x 220 (13.77 x 8.66)	550 x 350 (21.65 x 13.77)	800 x 550 (31.5 x 21.65)
Max. speed (X, Y and U, V axes)	m/min	3 (9.8 ft/min)	3 (9.8 ft/min)	3 (9.8 ft/min)
Integrated Collision Protection (ICP)		Standard on 5 axes	Standard on 5 axes	Standard on 5 axes
Taper machining				
Max. taper	°/mm	± 45/220 (± 30/220 standard)	± 45/400 (± 30/400 standard)	± 45/510 (± 30/510 standard)
	°/in	± 45/8.66 (± 30/8.66 standard)	± 45/15.75 (± 30/15.75 standard)	± 45/20.07 (± 30/20.07 standard)
Electrical supply (machine)				
Three-phase input voltage	V	380/400	380/400	380/400
Maximum consumption	kVA	12	12	12

* Width x depth x height ** Width x depth

CUT P 350 Pro / CUT P 550 Pro / CUT P 800 Pro

Dielectric

Paper filters		2 cartridges (option 4 cartridges)
Temperature control of clean water tank	°C	±0.1 (±2 °F)
Total volume of deionization resin (option)	l	20 (5.3 gal)
Max. injection pressure	bar	20

IPG Generator

Protection against electrolytic effects		From roughing through to finishing
Max. cutting speed	mm ² /min	400 (37.7 in ² /hour)
Min. finishing	µm Ra	0.08 (3.2 µ-inch RMS)

Numerical control

Position measurement system/resolution		Linear glass scales/0.050 µm (0.000002 in.)
Architecture		PC multiprocessors
Operating system		Windows
Screen		LCD 19" TFT (touch screen)
Input devices		Touch screen, mouse
Remote control		Standard
Part-program capacity		4 MB
Ethernet, USB ports		Standard

CUT P 350 Pro / CUT P 550 Pro

CUT P 800 Pro

Wire circuit

Wire diameters available	mm in	0.33 to 0.07 (0.33 to 0.15 std) 0.013 to 0.003 (0.013 to 0.006 std)	0.30 to 0.15 0.012 to 0.006
Type of wire guides		Closed diamond type without clearance	Closed diamond type without clearance
Permissible weights and types of spool (ISO standards)	kg lbs	1.6 (K100) to 8 (K160) 3.52 (K100) to 17.6 (K160)	25 (K250) 55 (K250)
Permissible weights and types of spool (JIS standards)	kg lbs	3 (P3) to 5 (P5) 6.6 (P3) to 11 (P5)	3 (P3) to 5 (P5) 6.6 (P3) to 11 (P5)
Programmable wire tension	daN	0.3 to 3	0.3 to 3
Automatic threading for wire	mm in	0.33 to 0.07 (0.33 to 0.15 std) 0.013 to 0.003 (0.013 to 0.006 std)	0.30 to 0.15 0.012 to 0.006
Automatic rethreading for wire	mm in	0.33 to 0.07 (0.33 to 0.15 std) 0.013 to 0.003 (0.013 to 0.006 std)	0.30 to 0.15 0.012 to 0.006

Options

Thermostabilization		Water in machine basis/ Air in cabine (UV axis)	—
Large spools	kg (lbs)	16 (35.2) K200, 25 (55) K250	—
TAPER-EXPERT		Advance	Advance
e-Connectivity		Option	Option
Extended taper cutting		From 30° to 45°	From 30° to 45°
Used wire processing		Wire chopper	Standard
Rotating axes		Index or servo-control	—
Automatic part leveling		3D Setup	—
Optical measuring system		OMS	—
3D probing		Renishaw probe	Renishaw probe
Alarm lamp		Four-color stacklight	Four-color stacklight
Advanced accuracy		< ± 2 µm positioning	—
Automatic slug management		Option	Option
E-tracking		Option	Option
Centralized automatic greasing		Manual (standard) Automatic (option)	Manual (standard) Automatic (option)

Special Kits

Molybdenum Wire Special Kit for intensive usage 24/7		Available	Available
--	--	-----------	-----------

CUT P 350 Pro

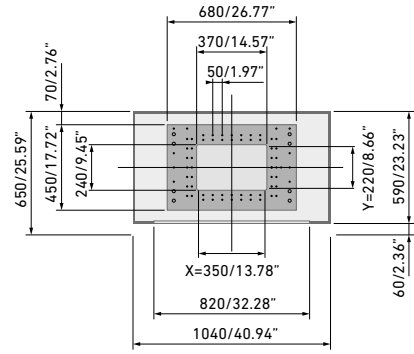
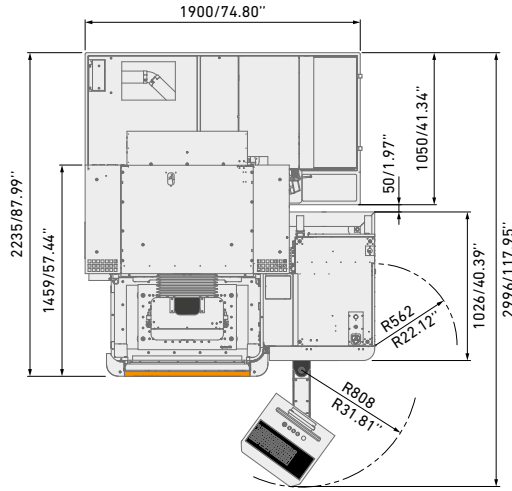
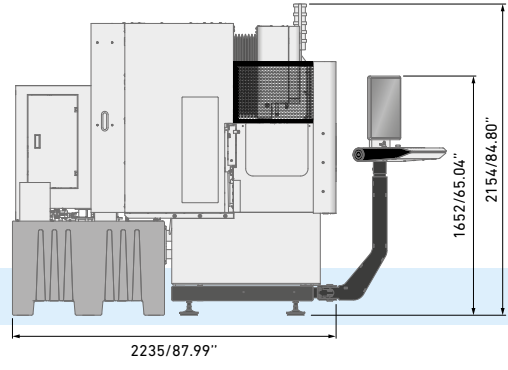
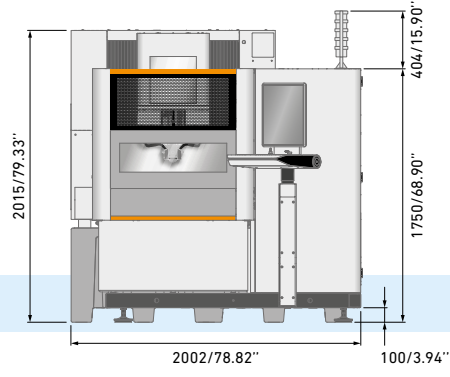

CUT P 550 Pro

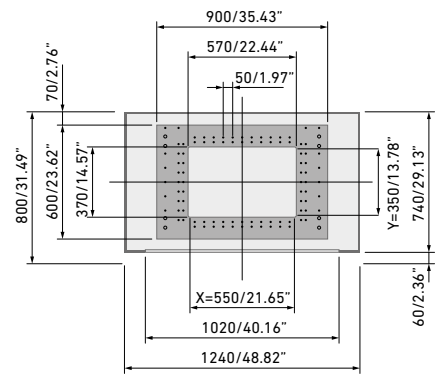
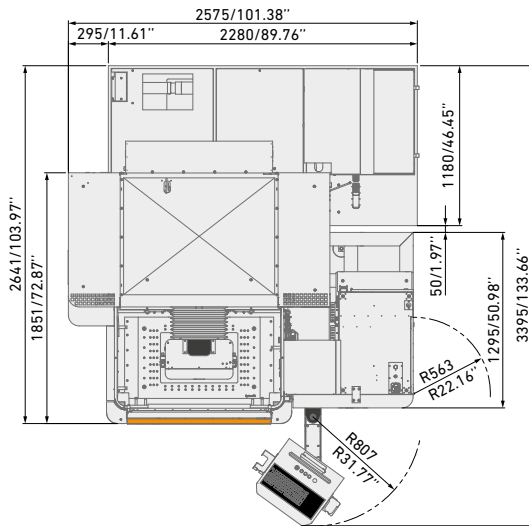
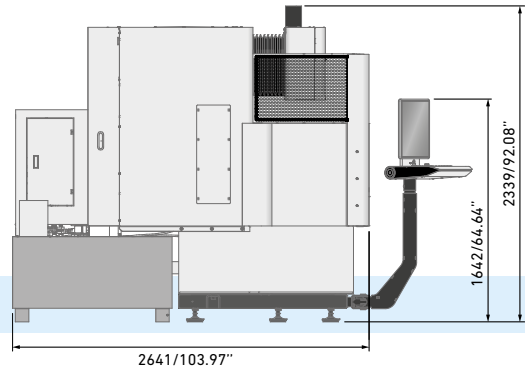
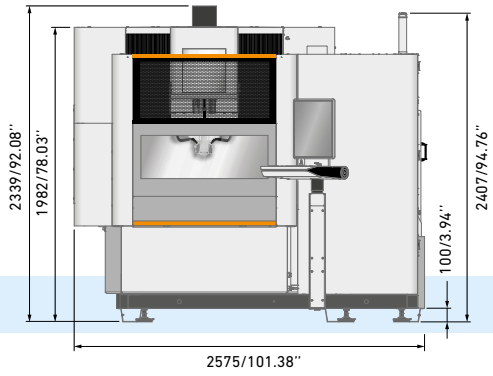

CUT P 800 Pro

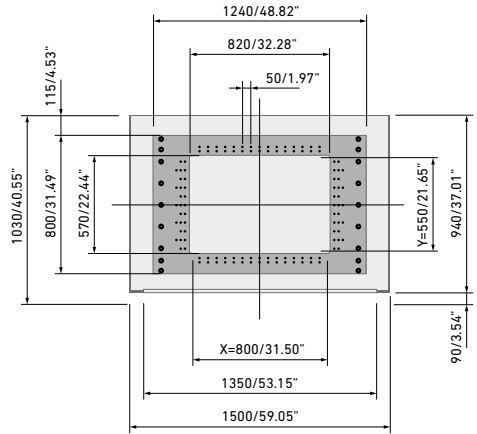
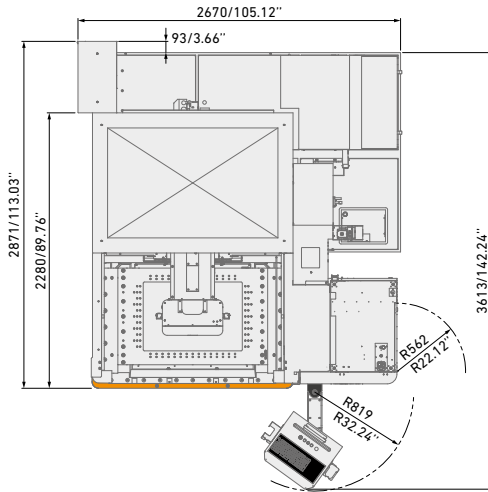
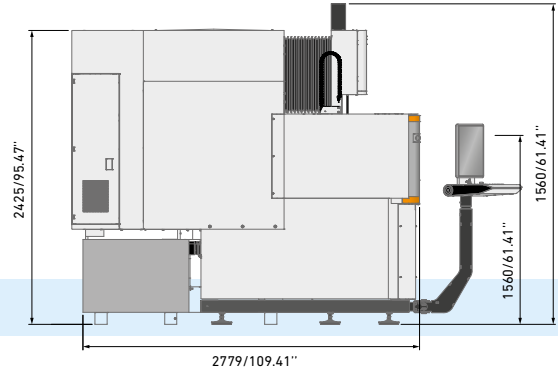
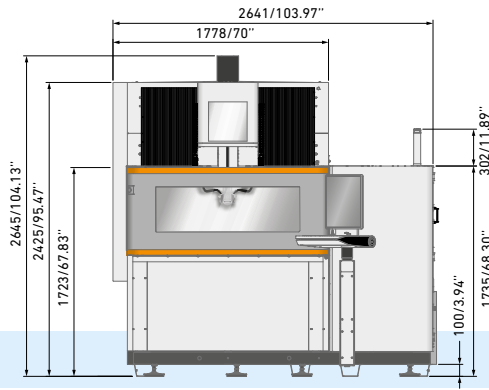

About GF Machining Solutions

Multi-technology solutions provider

Our commitment to you and your specific applications is proven by the value-adding intelligence, productivity and quality delivered by our multi-technology solutions. Your success is our chief motivator. That's why we are continuously advancing our legendary technical expertise. Wherever you are, whatever your market segment and whatever the size of your operation, we have the complete solutions and the customer-centric commitment to accelerate your success—today.

EDM (Electrical Discharge Machining)



Wire-cutting EDM

GF Machining Solutions' wire-cutting EDM is fast, precise and increasingly energy efficient. From ultraprecise machining of miniaturized components down to 0.02 mm to powerful solutions for demanding high-speed machining with respect to surface accuracy, our wire EDM solutions position you for success.

Die-sinking EDM

GF Machining Solutions is revolutionizing die-sinking EDM with features like iGAP technology to dramatically boost machining speed and reduce electrode wear. All of our die-sinking systems offer fast removal and deliver mirror finishes of Ra 0.1 µm (4 µin).

Hole-drilling EDM

GF Machining Solutions' robust hole-drilling EDM solutions enable you to drill holes in electrically conductive materials at a very high speed—and, with a five-axis configuration, at any angle on a workpiece with an inclined surface.

Tooling and Automation



Tooling

Our customers experience complete autonomy while maintaining extreme accuracy, thanks to our highly accurate System 3R reference systems for holding and positioning electrodes and work pieces. All types of machines can easily be linked, which reduces set-up times and enables a seamless transfer of workpieces between different operations.

Automation

Together with System 3R, we also provide scalable and cost-effective Automation solutions for simple, single machine cells or complex, multi-process cells, tailored to your needs.

Milling



Milling

Precision tool and mold manufacturers enjoy a competitive edge with our Mikron MILL S solutions' fast and precise machining. The Mikron MILL P machines achieve above-average productivity thanks to their high performance and Automation. Customers seeking fastest return on investment benefit from the affordable efficiency of our MILL E solutions.

High Performance Airfoil Machining

Our Liechti turnkey solutions enable the highly dynamic manufacturing of precision airfoils. Thanks to the unique performance and our expertise in airfoil machining, you increase productivity by producing at the lowest cost per part.

Spindles

As part of GF Machining Solutions, Step-Tec is engaged in the very first stage of each machining center development project. Compact design combined with excellent thermal and geometric repeatability ensure the perfect integration of this core component into the machine tool.

Software



Digitalization solutions

To drive its digital transformation, GF Machining Solutions acquired symmedia GmbH, a company specialized in software for machine connectivity. Together, we offer a complete range of Industry 4.0 solutions across all industries. The future requires the ability to adapt quickly to continual digital processes. Our intelligent manufacturing offers embedded expertise, optimized production processes, and workshop Automation: solutions for smart and connected machines.

Advanced manufacturing



Laser texturing

Aesthetic and functional texturing is easy and infinitely repeatable with our digitized Laser technology. Even complex 3D geometries, including precision parts, are textured, engraved, microstructured, marked and labeled.

Laser micromachining

GF Machining Solutions offers the industry's most complete line of Laser micromachining platforms optimized for small, high-precision features to meet the increasing need for smaller, smarter parts to support today's leading-edge products.

Laser Additive Manufacturing (AM)

GF Machining Solutions and 3D Systems, a leading global provider of additive manufacturing solutions and the pioneer of 3D printing, have partnered to introduce new metal 3D printing solutions that enable manufacturers to produce complex metal parts more efficiently.

Service + Success



We take you to new heights

Our Success Packs are designed to maximise your return on investment and empower you in your quest for success across all industrial segments. Our subscription packs feature a comprehensive range of services that guarantee the access and support you need to get the most out of your assets today, while preparing for the challenges of tomorrow. Our trusted experts backed by our latest cutting-edge, intelligent Digital Solutions, provide a full range of services.

eCatalog

Keep your equipment operating at peak precision and performance with our wide range of certified consumables and original wear parts. Our online catalog has it all (ecatalog.gfms.com).



Our locations

Switzerland

Headquarters
Biel/Bienne +++

Losone +++
Geneva ++
Langnau ++

Europe

Schorndorf, Germany ++
Coventry, United Kingdom ++
Agrate Brianza (MI), Italy ++
Barcelona, Spain ++
Marinha Grande, Portugal +
Massy, France +
La Roche Blanche, France +
Lomm, Netherlands ++
Altenmarkt, Austria ++
Warsaw, Poland ++
Brno, Czech Republic ++
Budapest, Hungary ++
Vällingby, Sweden +

America

USA
Lincolnshire (IL) ++
Chicago (IL) ++
Huntersville (NC) ++
Irvine (CA) ++

Toronto (Vaughan), Canada ++
Monterrey, Mexico ++
São Paulo, Brazil +
Caxias do Sul, Brazil +

Asia

China
Beijing +++
Changzhou ++
Shanghai ++
Chengdu ++
Dongguan ++
Hong Kong +

Yokohama, Japan ++
Taipei, Taiwan +
Taichung, Taiwan ++
Seoul, Korea ++
Singapore, Singapore ++
Petaling Jaya, Malaysia ++
Bangalore, India ++
Pune, India +
Hanoi, Vietnam ++

+ Plant ++ Center of Demonstration +++ Sales company

At a glance

We enable our customers to run their businesses efficiently and effectively by offering innovative Milling, EDM, Laser, Additive Manufacturing, Spindle, Tooling and Automation solutions. A comprehensive package of services completes our proposition.

www.gfms.com



© GF Machining Solutions Management SA, 2023
The technical data and illustrations are not binding.
They are not warranted characteristics and are
subject to change.